

Special Products and Service



User Manual

CONTENTS

1.0	Safety Instructions and Warnings	4
1.1	Introduction	4
1.4	Symbols Used	5
1.5	Contraindications / Limitations	6
1.6	Intended Use	6
1.7	Warning Notes.....	7
1.8	Operating Environment	7
2.0	Components / Key Parts.....	8
3.0	Assembly Instructions	9
3.1	Unpacking	9
3.2	Unboxing Stand Aid	9
3.3	Stand Aid Assembly	10
3.4	Electrical Connections.....	11
4.0	Final Inspection.....	11
5.0	Operating Instructions	12
5.1	Manoeuvring the Stand Aid	12
5.2	Raising and Lowering.....	12
5.3	Open / Close Stand Aid Legs	13
5.4	Emergency Stop Button	13
5.5	Mechanical Emergency Lowering.....	14
5.5.1	Manual Emergency Lowering.....	14
5.5.2	Electrical Emergency Lowering.....	14
5.6	Handset Operations.....	14
5.7	Battery	14
5.7.1	Charging the Battery Pack.....	15
5.8	Slings	15
6.0	Technical Specification	18
6.1	Mackworth Essentials SA180E Dimensions	18
6.2	Specifications	19
6.3	Electrical Specifications	19
6.4	Standards Applied	19

7.0	Environmental - Storage and Operating Conditions.....	20
7.1	Normal Operating Conditions	20
7.2	Shipping and Storage Conditions	20
8.0	Disposal	20
9.0	Fault Finding	21
10.0	General Inspection, Maintenance and Cleaning	22
10.1	Service	22
10.2	Inspection	22
10.3	Cleaning.....	23
10.3.1	General Cleaning	23
10.3.2	Disinfecting (if necessary).....	23
11.0	Warranty.....	25
12.0	Service Record History	26

1.0 SAFETY INSTRUCTIONS AND WARNINGS

1.1 Introduction



Please read and understand this manual in its entirety before using your Mackworth Essentials SA180E Stand Aid.

The information in this manual is important for the safety of anyone near the Mackworth Essentials SA180E Stand Aid and must be read and understood to help prevent injuries. It is also crucial to the proper operation and maintenance of the Stand Aid.

The Stand Aid is designed to be used in conjunction with slings and accessories. Please refer to any user guides supplied with these components while reviewing this manual.

Should any questions arise from reviewing this manual, contact your local authorised representative.

Failure to comply with warnings in this manual may result in; injury to the operator and/or client and/or damage to the Stand Aid or related components.

If, during the use of this device or as a result of its use a serious incident has occurred, please report it to the manufacturer and to your national authority.

Store this manual with the documents included with the Stand Aid and sling(s). Contents of this manual are subject to change without prior written notice. Ensure you are aware of the sling manufacturer's fitting instructions.



Do not attempt to use this equipment without first understanding the contents of this manual.



Unauthorised modifications on any Prism Medical UK product may affect its safety. The manufacturer will not be held responsible for any accident, incident or deficiencies of performance that occur as a result of any unauthorised modification to its products.



Do not use a clip fit sling on a lifting arm designed specifically for loop fitting slings.

1.4 Symbols Used

The Table below includes all Symbols from BS EN ISO 15223-1:2016 that can be found in this Manual and on the Product and what they represent. Refer back to this Table when you are unsure of what a symbol represents.













	Consult instructions before use		Caution – see instructions for use
	Manufacturer	SWL	Safe Working Load represents the maximum load rated for safe operation
	Packaging indicator – This way up		Date of manufacture
	Serial number		Packaging indicator – Keep dry
	Please observe local laws on recycling		For internal use only
	Temperature range	IP_{N₁}N₂	Degree of protection provided by enclosure. N ₁ : Ingress of particles N ₂ : Ingress of water
	Humidity range	MD	Medical Device
	Catalogue number	EC REP	European Authorised Representative

Table 1

1.5 Contraindications / Limitations

There are no known “contraindications” associated with the usage of the Mackworth Essentials SA180E, provided they are used as per manufacturer’s recommendations and guidelines. However, it is recommended that a client specific assessment is completed by a trained and knowledgeable health care professional to determine the method of transfer.

Prism Medical UK does not recommend a required number of care givers for the use of our products. This information and recommendation can only be provided after a thorough personalised, case specific assessment, as there are many factors that can influence these decisions.

1.6 Intended Use



For internal use only.

The Mackworth Essentials SA180E is a Standing Aid to be used by trained personnel. The Stand Aid is a medical device which carries out safe lifting and transfers of an individual from one resting surface to another (such as a shower chair to a bed). Prism Medical UK recommends that the transfer of a patient is fully risk assessed and conducted safely over a short distance only. Carrying out each transfer correctly for minimal strain or risk to the caregiver, while providing complete safety, dignity and comfort to the client. The Mackworth Essentials SA180E is suitable for patients in the SITTING position only, who have a degree of weight-bearing ability but require assistance to stand. By removing the foot tray, The Stand Aid can be used as a walking aid if competent and trained person completes an adequate risk assessment of the surroundings, and the patient is observed during use. The SA180E is designed to support and promote safe patient handling and transfer for both the patient and carer.

The Stand Aid is one of two components that makes this possible. The other component, the sling, is a specially designed fabric accessory that attaches to the Stand Aid by means of the boom Loop attachment and straps, and holds the patient during operation.

Please refer to the user guides supplied with the sling and reference them while reviewing this manual.

The functions of raising and lowering the boom, are accomplished by pressing buttons on the hand control. The opening and closing of the legs on the Stand Aid are of manual operation.



The device is used under instruction and the operation of the aid is undertaken by a trained carer.

A risk assessment must be performed before using any other manufactured slings or Stand Aid to ensure safe use can be established.

- The Mackworth Essentials SA180E is intended to be installed on a flat and levelled surface prior to use.
- The Stand Aid must be installed only by persons authorized by Prism Medical UK or who have the rights to install and commission the Stand Aid safe for use.
- Under no circumstance should the Mackworth Essentials SA180E or the entire system be put in control of a person who has not been properly trained in the use and care of this equipment. Failure to adhere to this warning may result in serious injury to the operator and/or the individual being transferred.
- In facilities where more than one operator will be responsible for using the Stand Aid and sling(s) it is imperative that all such members be trained in the Mackworth Essentials SA180E proper use. A training program should be established by the facility to acquaint new operators with this equipment.
- The Mackworth Essentials SA180E, and associated slings are not toys. Do not use it for unsafe practices. Do not allow children to play with the Stand Aid or any of its components.

- Your guarantee is void if persons unauthorized by Prism Medical UK perform work on the Stand Aid.
- To maintain optimum function, the Mackworth Essentials SA180E should be inspected and maintained on a regular basis. See section 'General Inspection, Maintenance and Cleaning' within this user manual.
- Any accessories used with this Stand Aid including belt(s), should be checked to ensure that they are in good working order. Check for signs of wear to each component prior to use. Report any unusual wear, or damage immediately to your local authorised dealer.
- The Mackworth Essentials SA180E and Slings(s) are intended only for transferring of a person. Prism Medical UK will not be responsible for any damage caused by the misuse, neglect or purposeful destruction of the Unit, and/or its associated components.
- The Stand Aid and its associated parts are certified to a maximum load of 180kg. Do not exceed the maximum rated load of any of the components.
- Ensure that a clear space is maintained around the Stand Aid. Before performing a transfer check for and move all obstacles out of the way.
- Your Product is for Aiding a human to transfer. Do not use it, or allow it to be used, for any other purpose.
- Protecting the people present, visually monitor the sling(s) loops connection points during transfer stages, so the belt remains firmly attached to the Stand Aid.
- In areas where children are prone to be present be vigilant when carrying out a transfer.
- To reduce the risk of unintended use, when the Stand Aid is not in use remove the sling(s) from the product to prevent entrapment or strangulation should the device be tampered with.
- Between Stand Aid and Body-Support Unit, the lowest maximum load shall always be used.



You may need to seek specialist advice on how to assist some people with specific moving and handling needs. Sources of advice include, but is not limited to, professional bodies and organisations, occupational therapist, physiotherapists, manual handling advisers and ergonomist with experience in health and social care.

1.7 Warning Notes



Your SA180E has been manufactured and tested to exceed BS EN 10535:2006. This does not mean that it can be used without care. ALL OPERATORS should have read the operating instructions and appreciate this warning section.

1. ALL Stand Aids are less stable on sloping surfaces. A 5-degree slope is the maximum permitted and then only with great care.
2. ALL Stand Aids are dangerous to the person being transferred when used recklessly or pushed at speed.

1.8 Operating Environment

The Mackworth Essentials SA180E is suitable for use within the professional health care facility environment as well as the home health care environment. The Stand Aid is not suitable for any special environments.

The Stand Aid is not intended to be used in environments where there are rapid changes in the environmental temperature and humidity during intended use.

2.0 COMPONENTS / KEY PARTS

Please see below to familiarise yourself with the components of the Mackworth Essentials SA180E Stand Aid. The images below show the contents of the Stand Aid. If you have not received all the components contact Prism Medical UK dealer immediately – contact details are provided on the last page of this manual.

Item	Description	Item	Description
1	Handle	11	Knee Pad Length Adjustment
2	Mast	12	Knee Pad Angle Adjustment
3	Lifting Arm	13	Star Handle Mast Fixture
4	Looped Sling Attachment	14	Front Castors
5	Handset	15	Slack Adjustment Star Handle
6	Manual E-Lower	16	Foot Tray
7	Battery	17	Product Serial Number Label
8	Lift Actuator	18	Manual Leg Lever Plate
9	Control Box	19	Rear braked Castors
10	Knee Pad		

Table 2

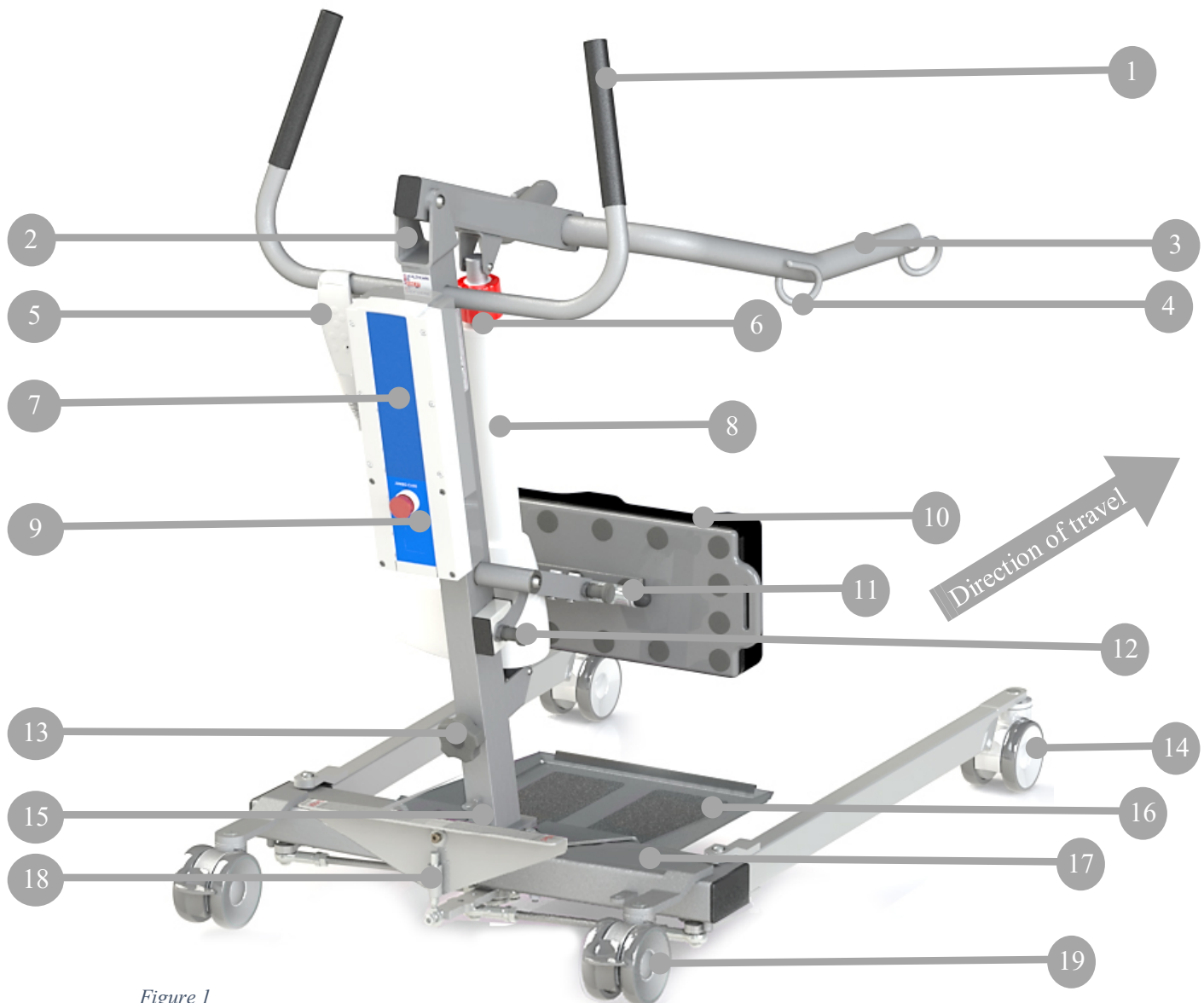

Figure 1

3.0 ASSEMBLY INSTRUCTIONS

3.1 Unpacking



Some of the parts are heavy and will need to be lifted with care. Items weighing over 20kg will require a two person lift. Please refer to (6.0) technical specifications for components weights.



The Stand Aid will arrive to you in a robust box, please be careful when removing the components from the box. Please read the user guide in full before operating.

This user manual should be kept safe for future reference.

The Stand Aid has been specifically designed to be installed in both the professional and home health care environments.

No matter the environment, health and safety factors should be considered to ensure the safety and essential performance of the Stand Aid and to avoid unnecessary damage or injuries to people within the area of the Stand Aid.

The environment in which the Stand Aid is situated in, whilst carrying out a transfer, is required to be on a flat surface with no steep inclines.

3.2 Unboxing Stand Aid



When using a sharp knife, be careful not to damage the product.

This section will summarize the layout of the Stand Aid Packaging and what is included in the Box. It is recommended a knife is used for smoother unpacking of the Stand Aid. The Stand Aid is packed into a single box (1200x800x1200), weighing approximately 50kg.

Using a knife to open the box around the perimeter, the box should open, and the internal packaging must be removed to access the product. It will include all the following components. It is recommended that the components are removed in the numerical order below.

1. Mast
2. Base
3. Fixings
4. Hand Control
5. Charging Lead
6. User Manual

3.3 Stand Aid Assembly

- A. Carefully open the box and remove all loose parts and excess packaging from the box.



2 person lift recommended for the following points.

- B. Carefully holding onto the handle and boom, lift the Stand Aid components out of the box. Place carefully onto the floor.
- C. With one person lifting up from the front castors and one person lifting up from the rear castors, raise the base from the box and place the Stand Aid base on a flat surface and ensure the rear braked castors are locked.
- D. Remove Star handle from the top of the base and slot the mast and boom assembly onto the base. (As shown in Fig. 2 and 3).
- E. Ensure all cables are clear from entrapment while fitting the base and mast together.



Figure 2



Figure 3



Please ensure both hands are on the handle when lifting the mast into position, as there is a risk of finger trap.

- F. When the mast is fully engaged with the base, fit and fully tighten the mast star handles in the following order (as shown in Fig. 4 and 5).



Figure 4



Ensure the mast is fully seated into the base and the mast locking wheel is in position and tight before using the Stand Aid.



Figure 5

NOTE: To disassemble the Stand Aid into the two main sections (Mast/boom and Base) simply follow the previous steps in reverse.

3.4 Electrical Connections



Connect all the cables to the control box as shown in the pictures opposite.

- A. Connect the lift actuator cable connector to the second port (marked No. 1) from the left side of the control box (as shown in Fig. 6).
- B. Connect the handset connector to the large port on the left side of the control box. A locator pin on the plug ensures correct orientation of the connector (as shown in Fig. 7).
- C. Connect the mains cable/power cord to the control box (as shown in Fig. 8).

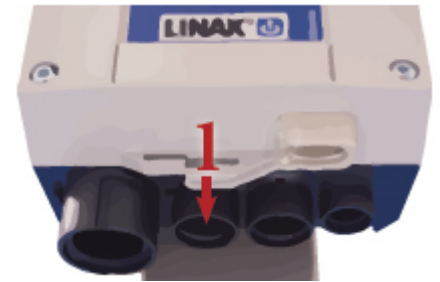

Figure 6



Figure 7



Figure 8



Ensure that all cables are located and secure before operating the Stand Aid.

4.0 FINAL INSPECTION

Before first operation of the Stand Aid:

- Confirm all cables are located and secure.
- Ensure the red emergency stop button on the control box is deactivated. (Rotate clockwise to release if required- Refer to section 5.4 for guidance).
- Press the up button on the handset and confirm the actuator raises the boom.
- Press the down button on the handset and confirm the actuator lowers the boom.
- Ensure that when you operate 'OPEN' on the manual leg spread lever, the legs operate accordingly.
- Ensure that when you operate 'CLOSE' on the manual leg spread lever, the legs operate accordingly.
- Press the red emergency stop button on the control box and check that actuators do not operate until the button is reset. (See section 5.4 for guidance).
- Check the manual emergency lowering function works properly. (See section 5.5 for guidance)
- Check the rear castors brakes function properly.
- Check the battery pack is fully charged.

Your Stand Aid is now ready to use.

5.0 OPERATING INSTRUCTIONS



The Stand Aid may be heavy for users and will need to be lifted with care, please operate the device with the use of the castors wherever possible to prevent any injury.

Appropriate training in lifting and handling procedures should be undergone by any person operating a Stand Aid, for their own and the client's safety and comfort. These instructions are designed to cover the method of using the Stand Aid.

5.1 Manoeuvring the Stand Aid

- A. To move the Stand Aid forward, hold onto the handle bar and push forward.
- B. When turning the Stand Aid, use both hands on the handle. Alternatively, it is possible to rotate the Stand Aid by applying the brake to a single rear castor and rotating the Stand Aid about the braked castor. This movement should be performed with a smooth, slow action to avoid swinging the patient unnecessarily.
- C. The Mackworth Essentials SA180E Stand Aid has two rear castors with brakes.
- D. The rear castors can be braked for rotation (by applying a single brake), lateral movement, and parking. To apply the brake, press the brake pedal down with your foot (as shown in Fig. 9). To release the brake, press the raised pedal towards the wheel (as shown in Fig. 10).
- E. During lifting, the rear wheels should remain unlocked so that the Stand Aid will not move.



The wheels should be locked if there is a risk of the Stand Aid moving to the patient. For example, when lifting the patient from the floor.



Figure 9



Figure 10

5.2 Raising and Lowering

The up and down movement of the lifting arm on the Mackworth Essentials SA180E Stand Aid is achieved by an electric actuator which is controlled by hand control. The hand control has two buttons with directional arrows up and down. The actuator stops automatically at the limit of travel in both directions.

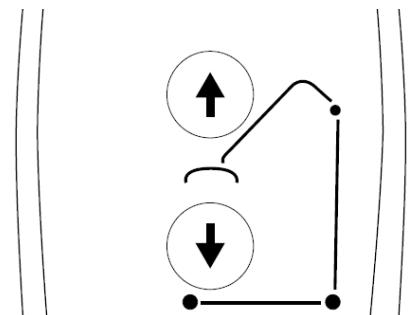

Figure 11

5.3 Open / Close Stand Aid Legs

The legs of Mackworth Essentials SA180E Stand Aid are manually opened using the leg lever plate. The legs can be opened to enable access around arm chairs or wheel chairs. When relocating the Stand Aid, manoeuvring through narrow doorways and/or passages, the Stand Aid legs should be in the closed position.

The legs on the base unit of the Stand Aid are operated by adjusting the leg lever plate, as shown in the photos below. To open the legs, press on “open” (Figure 13) and then to close the legs, press on “close” (Figure 16).



Figure 12



Figure 13



Figure 14



Figure 15



Figure 16



Figure 17

5.4 Emergency Stop Button

The Mackworth Essentials SA180E Stand Aid is fitted with an Emergency Stop button.

Push the Emergency Stop button (as shown in Fig. 18) to cut all power on the Stand Aid.

To resume power, release the emergency stop button by turning in a clockwise direction (indicated by arrows on the Emergency Stop button) as shown in Fig. 19.



Figure 18



Figure 19

5.5 Mechanical Emergency Lowering

5.5.1 Manual Emergency Lowering

In case of power failure, it is possible to mechanically lower a patient placed in Mackworth Essentials SA180E Stand Aid. Turn the manual lowering handle in clockwise direction (as shown in Fig. 20) to lower the boom until the boom reaches a safe position.



The manual emergency lowering system should be used only if the lowering procedures described in the previous section of the manual do not work. Should you have any concerns or questions contact your local authorised Prism Medical UK Representative.



Do not use the Stand Aid after the manual lowering mechanism has been used. The lift must be reset by a qualified technician after use. Contact your local authorised Prism Medical UK Service Provider.



Figure 20

5.5.2 Electrical Emergency Lowering

The Stand Aid lifting arm can be lowered by pushing the emergency lowering button on the control box with a suitable object, such as a pen nib or pencil (as shown in Fig. 21).

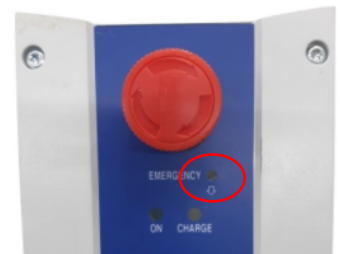

Figure 21

5.6 Handset Operations

The Hand Controls has 2 functions: Up and Down. This will raise and lower the Stand Aid lifting arm.

Press down on each symbol to operate the desired function. It is not possible to use two functions at the same time. Once the Stand Aid has reached the extent of its travel in a given direction, the actuator will automatically stop, allowing you to then choose the opposite direction.

The handset is attached to the control box via a flexible, coiled cable that is secured in place with a friction-fit plug. The coiled cable is designed to give the greatest number of options for carer positioning without having a trailing cable around the patient. The handset also incorporates a hook which gives the carer flexibility whilst moving/positioning the patient. Clear and easy to understand labelling of the buttons enable ease of use for the care giver.



Figure 22

5.7 Battery



The battery pack should never be stored for long periods of time without a regular charge.

The battery pack is protected encased unit located on top of the control box, on the rear of the product. The control box, below the battery, will inform the user when the battery is flat and requires charging, by an illuminated LED. An LED illuminate when the battery needs recharging. Complete the lift and place the battery on charge.

5.7.1 Charging the Battery Pack

The battery pack can be recharged via mains lead (terminated with a figure of eight plug)

- A. Fit the mains lead figure of eight plug into charger link cable (see Fig. 23).
- B. Plug the 3-pin mains plug into a suitable mains outlet and switch the mains supply on.
- C. Charging is automatic and will normally take eight to twelve hours to fully charge (from completely discharged state). You cannot overcharge the battery pack if left for longer periods of time.
- D. To return the Stand Aid to use, switch off the mains supply. Remove the figure of eight plug from the socket at the base of the control box.
- E. The Stand Aid is now ready for use.



Figure 23

5.8 Slings

Sling loops should be attached as follows:

1. Put the required sling loop onto your finger and thumb and open the selected sling loop up (Figure 24 & Figure 25).
2. Slide the sling loop onto the sling hook (Figure 26).
3. Follow the hook profile around until the sling loop is positioned at the base of the hook (Figure 27).



Figure 24



Figure 25



Figure 26



Figure 27

To remove the sling, simply reverse the processes shown in the above statements

Prism Medical UK recommend the use of the Mackworth Healthcare or Care-Ability manufactured sling range (type 'B' applied part) to be utilised with the Mackworth Essentials SA180E Stand Aid. It is at the user's discretion to use alternative supplied product. In utilising another manufacturer's sling, checks must first be made to ensure the sling is safe to use and meets the requirements of BS EN ISO 10535 before its use.

The slings with a safe working load of 180kg that can be used with the Mackworth Essentials SA180E are shown below in Table's 3 and 4, complete with product codes. For all components, the lowest maximum safe working load must always be adhered too

Size	Mackworth Sling Range - Product Material and Code	
	Polyester Solid	
Holly - Stand Aid Transport Sling		
XS	1201HL7600	
Small	1201HL7500	
Medium	1201HL7400	
Large	1201HL7300	
XL	1201HL7200	
XXL	1201HL7100	
XXXL	1201HL7000	
Maple - Stand Aid Sling With Back Support		
XS	1201MP7600	
Small	1201MP7500	
Medium	1201MP7400	
Large	1201MP7300	
XL	1201MP7200	
XXL	1201MP7100	
XXXL	1201MP7000	
Poplar - Stand Aid Sling		
XS	1201PL7600	
Small	1201PL7500	
Medium	1201PL7400	
Large	1201PL7300	
XL	1201PL7200	
XXL	1201PL7100	
XXXL	1201PL7000	

Table 3

Size	Care Ability Sling Range - Product Material and Code			
	Polyester	Mesh	Spacer	Parachute
CA800 Chest Sling				
P1	CA800PP1	CA800MP1	CA800SP1	CA800PAP1
P2	CA800PP2	CA800MP2	CA800SP2	CA800PAP2
P3	CA800PP3	CA800MP3	CA800SP3	CA800PAP3
P4	CA800PP4	CA800MP4	CA800SP4	CA800PAP4
P5	CA800PP5	CA800MP5	CA800SP5	CA800PAP5
X Small	CA800PXS	CA800MXS	CA800SXS	CA800PAXS
Small	CA800PS	CA800MS	CA800SS	CA800PAS
Small/Medium	CA800PSM	CA800MSM	CA800SSM	CA800PASM
Medium	CA800PM	CA800MM	CA800SM	CA800PAM
Medium/Large	CA800PML	CA800MML	CA800SML	CA800PAML

Large	CA800PL	CA800ML	CA800SL	CA800PAL
X Large	CA800PXL	CA800MXL	CA800SXL	CA800PAXL
XX Large	CA800PXXL	CA800MXXL	CA800SXXL	CA800PAXXL
CA801 Chest Sling				
P1	CA801PP1	CA801MP1	CA801SP1	CA801PAP1
P2	CA801PP2	CA801MP2	CA801SP2	CA801PAP2
P3	CA801PP3	CA801MP3	CA801SP3	CA801PAP3
P4	CA801PP4	CA801MP4	CA801SP4	CA801PAP4
P5	CA801PP5	CA801MP5	CA801SP5	CA801PAP5
X Small	CA801PXS	CA801MXS	CA801SXS	CA801PAXS
Small	CA801PS	CA801MS	CA801SS	CA801PAS
Small/Medium	CA801PSM	CA801MSM	CA801SSM	CA801PASM
Medium	CA801PM	CA801MM	CA801SM	CA801PAM
Medium/Large	CA801PML	CA801MML	CA801SML	CA801PAML
Large	CA801PL	CA801ML	CA801SL	CA801PAL
X Large	CA801PXL	CA801MXL	CA801SXL	CA801PAXL
XX Large	CA801PXXL	CA801MXXL	CA801SXXL	CA801PAXXL
CA900 Transport Sling				
P1	CA900PP1	CA900MP1	CA900SP1	CA900PAP1
P2	CA900PP2	CA900MP2	CA900SP2	CA900PAP2
P3	CA900PP3	CA900MP3	CA900SP3	CA900PAP3
P4	CA900PP4	CA900MP4	CA900SP4	CA900PAP4
P5	CA900PP5	CA900MP5	CA900SP5	CA900PAP5
X Small	CA900PXS	CA900MXS	CA900SXS	CA900PAXS
Small	CA900PS	CA900MS	CA900SS	CA900PAS
Small/Medium	CA900PSM	CA900MSM	CA900SSM	CA900PASM
Medium	CA900PM	CA900MM	CA900SM	CA900PAM
Medium/Large	CA900PML	CA900MML	CA900SML	CA900PAML
Large	CA900PL	CA900ML	CA900SL	CA900PAL
X Large	CA900PXL	CA900MXL	CA900SXL	CA900PAXL
XX Large	CA900PXXL	CA900MXXL	CA900SXXL	CA900PAXXL

Table 4

6.0 TECHNICAL SPECIFICATION

6.1 Mackworth Essentials SA180E Dimensions

All dimensions below are shown in millimetres.

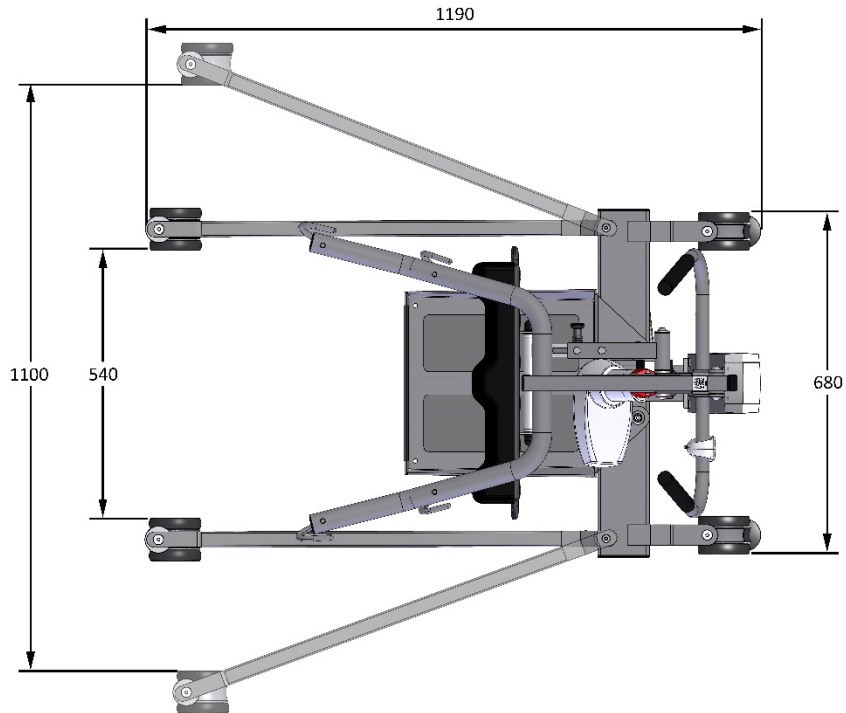

Figure 28

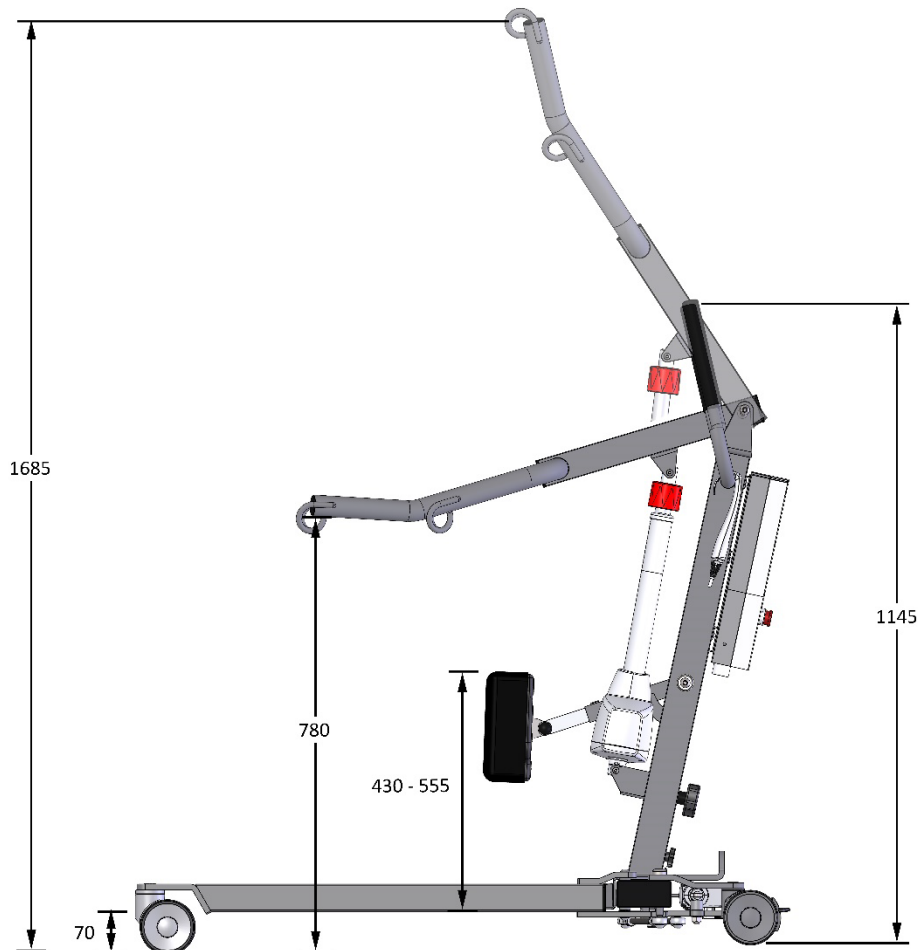

Figure 29

6.2 Specifications

Dimensions	
Turning Circle	1230mm
Overall Height	1720mm
Overall Width	680mm
Ground Clearance	33mm
Front and Rear Castors Size	100mm

Table 5

Weights:	
Safe Working Load (SWL)	180 kg
Full Product	47 kg
Base Assembly	23 kg
Mast & Boom Assembly	24 kg

Table 6

Operational Forces	
Moving Force (with 180 kg)	104.5 N
Moving Force (with 0 kg)	20 N
Operation of the Brake	35 N
Handset	4.5 N
E-Stop Button	12 N
Manual Leg Lever (with 0kg)	80 N

Table 7

6.3 Electrical Specifications

Battery type:	2 x 12-volt Rechargeable sealed lead acid.
Battery capacity:	24 V DC, 1 x 2.9 Ah
Charger rated input:	230VAC 50/60Hz
Charger rated output:	27.4/29.0 VDC @ 0.8A

Electric Shock Protection

Charger:	Class II *Lift - internal power source
Degree of shock protection:	Type B *Lift - internal power source
Duty cycle:	10% Use – 90% Rest (90 seconds use - 810 seconds rest)
IP rating, control box:	IPX4
IP rating, battery:	IPX5
IP rating, handset:	IPX4

Expected Product Lifetime

10 yrs. depending usage and compliance to maintenance, servicing and LOLER inspections.

6.4 Standards Applied

The standards that have been applied to the device are as follows:

- EN 10535:2006 Hoists for the transfer of disabled persons. Requirement and test methods.

7.0 ENVIRONMENTAL - STORAGE AND OPERATING CONDITIONS

The Mackworth Essentials SA180E is intended for internal use within normal environmental conditions.



It is not intended to be used in environments where there are rapid changes in the environmental temperature and humidity during intended use.

7.1 Normal Operating Conditions

+5°C to +40°C (41°F to 104°F) at a relative humidity between 15% to 90% RH, non-condensing but not requiring a water vapour pressure greater than 50hPa and atmospheric pressure between 700hPa to 1060hPa.

7.2 Shipping and Storage Conditions

-25°C to +5°C (-13°F to 41°F) with any humidity level.

+5°C to +35°C (41°F to 95°F) at a relative humidity up to 90%.

+35°C to 70°C (95°F to 158°F) non-condensing at a water vapour pressure up to 50hPa.

8.0 DISPOSAL



When the Stand Aid has completed its life cycle and can no longer perform to its intended use safely the Stand Aid must be decommissioned by an approved Service Engineer. The following specifies the importance of correct disposal procedure including local laws and being environmentally friendly.

Please observe the local laws on recycling and respect the current laws for disposal within the community the device is being used within. If there is any uncertainty of the below guidelines, contact your local authorities to determine the proper method of disposal of potentially biohazardous parts and accessories.

The relevant components utilised in the manufacture of the device that can be recycled at the end of the device life are:

Fully recyclables:	Consideration when Recycling:
Steel frame (Frame, Upper Assembly, Legs)	Knee Pad
Castors	Lift Actuator
Initial packaging of the device (cardboard)	Control Box
Metallic fixing – screws etc.	Handset + Cables
Foot Tray	Battery

Table 8



The product may be contaminated and has to be disinfected before recycling or disposal. See section 10.3 'Cleaning' for details of how to do this.

9.0 FAULT FINDING

If a problem arises with the Stand Aid, the Table below will hopefully assist in determining the fault and what actions you can take. If the fault cannot be found or the fault is found and the action guide does not provide a fix (e.g. – a damaged wire would need replacement), contact your local Prism Medical UK authorised dealer immediately, a service engineer will be required to repair the Stand Aid. Contact details can be found on the last page of this manual.

Fault	Action
Stand Aid doesn't turn on	<ul style="list-style-type: none"> • Check the E-Stop button on the control box has not been activated. • Check the Handset is correctly connected to the correct control box port. • Check the Handset lead is not damaged, e.g. cuts and breaks. • Check to see if the Stand Aid battery is out of charge and requires charging. • Check the Battery is located correctly on top of the control box. • Check for any damage to the battery terminals, e.g. burns and breaks. • Perform a visual check on the Control box for any damage.
Stand Aid doesn't charge	<ul style="list-style-type: none"> • Check the Charger plug is turned on at the power supply. • Check that the Charger Lead is connected correctly to the Control Box • Check charging lead for damage, e.g. cuts and breaks. • Check that the Battery is connected properly with the Control Box. • Inspect the Battery terminals for any damage, e.g. burns and breaks. • Inspect the Control Box terminals for any damage, e.g. burns and breaks
Stand Aid doesn't lift	<ul style="list-style-type: none"> • Check if the Stand Aid is plugged into Charge. (Stand Aid will not raise and lower while on charge) • Check that the Lift Actuator to Control Box cable is connected properly between the two ports. • Check the Lift Actuator to Control Box cable for damage, e.g. cuts and breaks. • Inspect the Lift Actuator for any signs of damage which could affect its function, including the Port. E.g. Large Cracks and breaks, electrical burns. • Inspect the Control Box Port for any damage. E.g. electrical burns, breaks.
Stand Aid has power but does not respond to handset commands.	<ul style="list-style-type: none"> • Check the Handset is correctly connected to the Control Box. • Check that the Lift Actuator Cables are both connected to the Control Box. • Check the Handset cable is not damaged, e.g. cuts and breaks. • Check the Lift Actuator Cable for damage, e.g. cuts and breaks • Check the Control Box Handset Port for any damage. E.g. cracks and electrical burns.

Table 9

10.0 GENERAL INSPECTION, MAINTENANCE AND CLEANING

10.1 Service



No service is to be carried out on the SA180E Stand Aid while transferring a person to reduce the risk of injury. Service must be completed by a Prism Medical UK authorised Service Engineer. Do not attempt to service the product yourself, or warranty is void.

To ensure the safety and continued good function of your Stand Aid, routine service must be performed on your Mackworth Essentials SA180E Stand Aid.

Service should be completed by a Prism Medical UK approved service engineer every 6 months to ensure the products required standard is maintained. The service history of the product should be documented each service in the Service Log at the back of this User Manual.



When the Stand Aid is serviced, the 6 month service checklist must be completed for the SA180E Stand Aid.

Service Manual Document Number: 995064.

Spare Parts Manual Document Number: 992064

The Service must be completed every 6 months after installation of the Stand Aid to comply with LOLER Regulations.

The Mackworth Essentials SA180E Stand Aid has an expected Service Life of 10 Years.

Contact your local authorised Prism Medical UK dealer if you:

- Need more information.
- Have any questions about the use or service of your Stand Aid.
- Notice any change in the performance.
- Want to report an unexpected occurrence.
- Want to arrange a service.
- Need to ascertain necessary information for replacement parts and components.

Contact details of your local Prism Medical UK dealer are shown on the last page of this manual.

10.2 Inspection

Inspection is to be completed prior to each use by the user of the Stand Aid.



Should any of the components in the table below fail the inspection, DO NOT use the Stand Aid. Contact your local authorised dealer for service – contact details are on the last page of this manual. Ensure all component inspections in the Table below are completed prior to each use of the Stand Aid.

Check List Before Use

Component	Service/Inspection required
Generic	Visual inspection of the external of the Stand Aid. Significant damage that may affect the function of the Stand Aid along with a clear safety hazard is unacceptable.
	Check the Labelling on the Stand Aid to ensure they are all still legible, this includes the Serial Number and other important markings. If labels are not legible, then contact your local authorised dealer immediately.
	Check all main nuts and bolts to see if they are loose, If they are not tight or you have concerns, then contact your local authorised dealer immediately.
Certification	An authorised/competent service company or person will issue a test certificate after satisfactory completion of the LOLER inspection. The certificate will be valid for 6 months.
Battery Pack	The battery pack should not require maintenance other than the regular charging as detailed in the charging instructions.

Emergency Stop Button	Check the emergency stop button functionality
Manual Emergency Lower	Check the manual emergency lower functionality.
Actuator	The actuator should not require maintenance other than checking for correct operation, listening for unusual noise and checking for any damage.
Manual Leg Lever Plate	Ensure the Leg lever plate is functional and the legs are opening/closing as intended. The operation should be smooth and not require additional force to operate.
Castors	Check the brake functionality on each rear castor. Check all castor fixing points. Check that each castor runs free and rotates easily. Remove any build-up of hair, fluff, dust etc.
Knee Pad	Inspect the Knee Pad for damage including cuts and breaks. Ensure all height adjustment to the Knee Pad is moving freely and is not jamming.
Leg Pivot Points	Check the smooth opening and closing of the legs.
Control Box	Inspect all male plugs and female sockets for correct fitting. Inspect the hand control functionality.
Foot Tray	Ensure the Foot Grips are still applied and undamaged. Check Foot Tray for permanent deformation.
Mast	Ensure the mast fully engages into the base housing. Check the operation of the mast locking hand wheel. Check the actuator mounting brackets for excessive wear.
Boom	Check the attachment of the boom to the mast, ensure all fixing points are secure and free from wear.
Sling attachment Points	Inspect the sling Looped attachments for any damage, sharp edges and excessive wear.

Table 10

10.3 Cleaning

Please follow the cleaning guidelines below on cleaning and disinfecting the Stand Aid.

10.3.1 General Cleaning



It is recommended to clean the Mackworth Essentials SA180E and accessories before use by a different person, reducing the risk of cross-contamination.

The exterior of the Mackworth Essentials SA180E can be cleaned using a damp soapy cloth for general cleaning duties. Please ensure the cloth is damp and not wet. Ensure the exterior of the device is dry after cleaning. Dry using a clean dry cloth.

10.3.2 Disinfecting (if necessary)

Should the Stand Aid require a more thorough clean, the use of the Actichlor™ disinfectant product (which is widely available in tablet form and used throughout the health care industry) is recommended.



Follow the manufacturer's safety instructions for the use of the cleaning product before use to ensure safe use for the operator and the patient.

Ensure the cloth is damp before the cleaning process.

Application is through a clean damp cloth applied to wipe the device down. Use in the following dilutions to ensure an effective clean:

- Actichlor™ dissolvable chlorine tablets provide a concentration of 1000 ppm of available chlorine (0.1%) per 1 tablet

- 1 tablet (1.7g formed tablet (x1)) will create a virucidal solution, diluted in 1 litre of water to provide effective means to clean a “dirty” device. This is also ideal for use after an outbreak of the Norovirus/winter vomiting and can be used as a precaution against C.Diff. It is effective against viruses, bacteria, spores, yeasts and moulds.
- The contact time against the outer components of the device should be for 5 minutes to prevent any virucidal infections without a degradation to the functionality of the device. 5 minutes is a recommended contact time. The device can withstand a longer contact period but the 5 minute recommendation as a minimum must be followed to provide an effective cleaning regime.
- Blood spills should be dealt with by an increased concentration of the solution – please refer to the instructions on the manufacturers product labelling.

Dilution chart					
Product used as	Device condition	Concentration (ppm)	Dilution qty* (l)	Tablets per 1l (0.26gal)	Contact time (minutes)
Bactericidal	Clean	200	5 (1.32gal)	1	1
	Dirty	1000	1 (0.26gal)	1	5
Yeasticidal	Clean	200	5 (1.32gal)	1	1
	Dirty	1000	1 (0.26gal)	1	5
Fungicidal	Clean	2000	1 (0.26gal)	2	15
	Dirty	5000	1 (0.26gal)	5	15
Mycrobactericidal	Clean	1000	1 (0.26gal)	1	15
	Dirty	5000	1 (0.26gal)	5	15
Virucidal	Clean	500	2 (0.53gal)	1	5
	Dirty	1000	1 (0.26gal)	1	5
Sporcidal (C.Diff)	Clean	1000	1 (0.26gal)	1	10
	-	-	-	-	-
Sporcidal	Clean	5000	1 (0.26gal)	5	10
	-	-	-	-	-

* Dilution is made with water. DO NOT dilute within any other medium.

- When diluted in water, one tablet gives 1000ppm of available chlorine.
- The concentration of the solution depends upon whether the object being cleaned is noticeably dirty (indicated in the table by “Device condition”).

Table 11

Handling and storage safety precautions when using this cleaning agent:

Advice on Safe Handling



- Avoid contact with skin and eyes.
- Do not breathe dust/fumes/gas/mist/vapours/spray.
- Use only with adequate ventilation.
- Wash hands thoroughly after handling.
- Mixing this product with acid or ammonia releases chlorine gas.

Hygiene Measures

Handle in accordance with good industrial hygiene and safety practice. Remove and wash contaminated clothing before re-use. Wash face, hands and any exposed skin thoroughly after handling.

Conditions for Safe Storage



- Keep out of reach of children.
- Keep container tightly closed.
- Store in suitable labelled containers.
- Storage temperature: 0-25°C (32-77°F).

Individual Protective Measures

Hand protection: Gloves

Dissolve

Dissolve in cold water – With no agitation, 1 tablet will take approximately 10 minutes to fully dissolve in the water used.

The information above has been extracted from the Actichlor™ MSDS (Manufacturers Safety Data Sheet). For a full review of the data please follow the link below:

<http://www.nhs.gov.uk/media/236215/msds-actichlor-plus.pdf>

11.0 WARRANTY

This guarantee does not affect or in any way limit your Statutory Rights.

1. Prism Medical UK guarantees the Mackworth Essentials SA180E, supplied as new, against failure within the period of 12 months from the date of purchase by virtue of defects in material or workmanship. (Excluding Batteries)
2. The liability of Prism Medical UK under terms of this guarantee shall be limited to the replacement or the defective part(s) to the sales distributor, dealer, agent, person or entity which purchased the equipment from Prism Medical UK. In no event shall Prism Medical UK incur liability for any consequential or unforeseeable losses.
3. This equipment guarantee shall be void if the equipment is not serviced by Prism Medical UK or its authorized agents, in accordance with manufacturer’s recommendations, or if any unauthorized persons carry out work on the equipment.
4. This guarantee does not apply to failure attributable to normal wear and tear, damage by natural forces, user neglect or misuse or to deliberate destruction.
5. Do not attempt to service the product yourself, or warranty is void.
6. Removal of the warranty label on the side of the control box will result in the Warranty becoming void.

SERVICE RECORD HISTORY

Complete this section after each service, repair inspection and/or maintenance.

Date: _____		Time: _____	
Service Type: <input type="checkbox"/> Periodic inspection <input type="checkbox"/> Monthly inspection <input type="checkbox"/> 6-month inspection <input type="checkbox"/> Repair <input type="checkbox"/> Yearly inspection <input type="checkbox"/> Other			
Completed by: (printed name).	 (signature)	
Company:			
Remarks & Action Taken:			
Device left in a safe usable condition: YES. <input type="checkbox"/> NO <input type="checkbox"/> (if "NO" explain in remarks the action taken)			

Date: _____		Time: _____	
Service Type: <input type="checkbox"/> Periodic inspection <input type="checkbox"/> Monthly inspection <input type="checkbox"/> 6-month inspection <input type="checkbox"/> Repair <input type="checkbox"/> Yearly inspection <input type="checkbox"/> Other			
Completed by: (printed name).	 (signature)	
Company:			
Remarks & Action Taken:			
Device left in a safe usable condition: YES. <input type="checkbox"/> NO <input type="checkbox"/> (if "NO" explain in remarks the action taken)			

Date: _____		Time: _____	
Service Type: <input type="checkbox"/> Periodic inspection <input type="checkbox"/> Monthly inspection <input type="checkbox"/> 6-month inspection <input type="checkbox"/> Repair <input type="checkbox"/> Yearly inspection <input type="checkbox"/> Other			
Completed by: (printed name).	 (signature)	
Company:			
Remarks & Action Taken:			
Device left in a safe usable condition: YES. <input type="checkbox"/> NO <input type="checkbox"/> (if "NO" explain in remarks the action taken)			

Date: _____	Time: _____
Service Type: <input type="checkbox"/> Periodic inspection <input type="checkbox"/> Monthly inspection <input type="checkbox"/> 6-month inspection <input type="checkbox"/> Repair <input type="checkbox"/> Yearly inspection <input type="checkbox"/> Other	
Completed by: (printed name). (signature)	
Company:	
Remarks & Action Taken:	
Device left in a safe usable condition: YES. <input type="checkbox"/> NO <input type="checkbox"/> (if "NO" explain in remarks the action taken)	

Date: _____	Time: _____
Service Type: <input type="checkbox"/> Periodic inspection <input type="checkbox"/> Monthly inspection <input type="checkbox"/> 6-month inspection <input type="checkbox"/> Repair <input type="checkbox"/> Yearly inspection <input type="checkbox"/> Other	
Completed by: (printed name). (signature)	
Company:	
Remarks & Action Taken:	
Device left in a safe usable condition: YES. <input type="checkbox"/> NO <input type="checkbox"/> (if "NO" explain in remarks the action taken)	

Date: _____	Time: _____
Service Type: <input type="checkbox"/> Periodic inspection <input type="checkbox"/> Monthly inspection <input type="checkbox"/> 6-month inspection <input type="checkbox"/> Repair <input type="checkbox"/> Yearly inspection <input type="checkbox"/> Other	
Completed by: (printed name). (signature)	
Company:	
Remarks & Action Taken:	
Device left in a safe usable condition: YES. <input type="checkbox"/> NO <input type="checkbox"/> (if "NO" explain in remarks the action taken)	

Date: _____	Time: _____
Service Type: <input type="checkbox"/> Periodic inspection <input type="checkbox"/> Monthly inspection <input type="checkbox"/> 6-month inspection <input type="checkbox"/> Repair <input type="checkbox"/> Yearly inspection <input type="checkbox"/> Other	
Completed by: (printed name). (signature)	
Company:	
Remarks & Action Taken:	
Device left in a safe usable condition: YES. <input type="checkbox"/> NO <input type="checkbox"/> (if "NO" explain in remarks the action taken)	

Date: _____		Time: _____	
Service Type: <input type="checkbox"/> Periodic inspection <input type="checkbox"/> Monthly inspection <input type="checkbox"/> 6-month inspection <input type="checkbox"/> Repair <input type="checkbox"/> Yearly inspection <input type="checkbox"/> Other			
Completed by: (signature)	
Company:			
Remarks & Action Taken:			
Device left in a safe usable condition: YES. <input type="checkbox"/> NO <input type="checkbox"/> (if "NO" explain in remarks the action taken)			

Date: _____		Time: _____	
Service Type: <input type="checkbox"/> Periodic inspection <input type="checkbox"/> Monthly inspection <input type="checkbox"/> 6-month inspection <input type="checkbox"/> Repair <input type="checkbox"/> Yearly inspection <input type="checkbox"/> Other			
Completed by: (signature)	
Company:			
Remarks & Action Taken:			
Device left in a safe usable condition: YES. <input type="checkbox"/> NO <input type="checkbox"/> (if "NO" explain in remarks the action taken)			

Date: _____		Time: _____	
Service Type: <input type="checkbox"/> Periodic inspection <input type="checkbox"/> Monthly inspection <input type="checkbox"/> 6-month inspection <input type="checkbox"/> Repair <input type="checkbox"/> Yearly inspection <input type="checkbox"/> Other			
Completed by: (signature)	
Company:			
Remarks & Action Taken:			
Device left in a safe usable condition: YES. <input type="checkbox"/> NO <input type="checkbox"/> (if "NO" explain in remarks the action taken)			

Date: _____		Time: _____	
Service Type: <input type="checkbox"/> Periodic inspection <input type="checkbox"/> Monthly inspection <input type="checkbox"/> 6-month inspection <input type="checkbox"/> Repair <input type="checkbox"/> Yearly inspection <input type="checkbox"/> Other			
Completed by: (signature)	
Company:			
Remarks & Action Taken:			
Device left in a safe usable condition: YES. <input type="checkbox"/> NO <input type="checkbox"/> (if "NO" explain in remarks the action taken)			

Date: _____		Time: _____	
Service Type: <input type="checkbox"/> Periodic inspection <input type="checkbox"/> Monthly inspection <input type="checkbox"/> 6-month inspection <input type="checkbox"/> Repair <input type="checkbox"/> Yearly inspection <input type="checkbox"/> Other			
Completed by: (signature)	
Company:			
Remarks & Action Taken:			
Device left in a safe usable condition: YES. <input type="checkbox"/> NO <input type="checkbox"/> (if "NO" explain in remarks the action taken)			

Date: _____		Time: _____	
Service Type: <input type="checkbox"/> Periodic inspection <input type="checkbox"/> Monthly inspection <input type="checkbox"/> 6-month inspection <input type="checkbox"/> Repair <input type="checkbox"/> Yearly inspection <input type="checkbox"/> Other			
Completed by: (signature)	
Company:			
Remarks & Action Taken:			
Device left in a safe usable condition: YES. <input type="checkbox"/> NO <input type="checkbox"/> (if "NO" explain in remarks the action taken)			

Date: _____		Time: _____	
Service Type: <input type="checkbox"/> Periodic inspection <input type="checkbox"/> Monthly inspection <input type="checkbox"/> 6-month inspection <input type="checkbox"/> Repair <input type="checkbox"/> Yearly inspection <input type="checkbox"/> Other			
Completed by: (signature)	
Company:			
Remarks & Action Taken:			
Device left in a safe usable condition: YES. <input type="checkbox"/> NO <input type="checkbox"/> (if "NO" explain in remarks the action taken)			

Date: _____		Time: _____	
Service Type: <input type="checkbox"/> Periodic inspection <input type="checkbox"/> Monthly inspection <input type="checkbox"/> 6-month inspection <input type="checkbox"/> Repair <input type="checkbox"/> Yearly inspection <input type="checkbox"/> Other			
Completed by: (signature)	
Company:			
Remarks & Action Taken:			
Device left in a safe usable condition: YES. <input type="checkbox"/> NO <input type="checkbox"/> (if "NO" explain in remarks the action taken)			

User notes:

User notes:

Dealer/service contact details:

Contact Us

Units 5 and 6 Lower Vicarage
Road
Southampton
Hampshire
SO19 7RJ
T: 02380 420678
E: info@easycare systems.co.uk



www.easycare systems.co.uk

