

## SatinSheet 4Direction DrawSheet Instruction for Use



# SatinSheet 4Direction DrawSheet Instruction for Use

## Index

Illustrations .....	3
User manual – English .....	4

## Positioning different sizes of SatinSheet BaseSheet 2Direction on a mattress

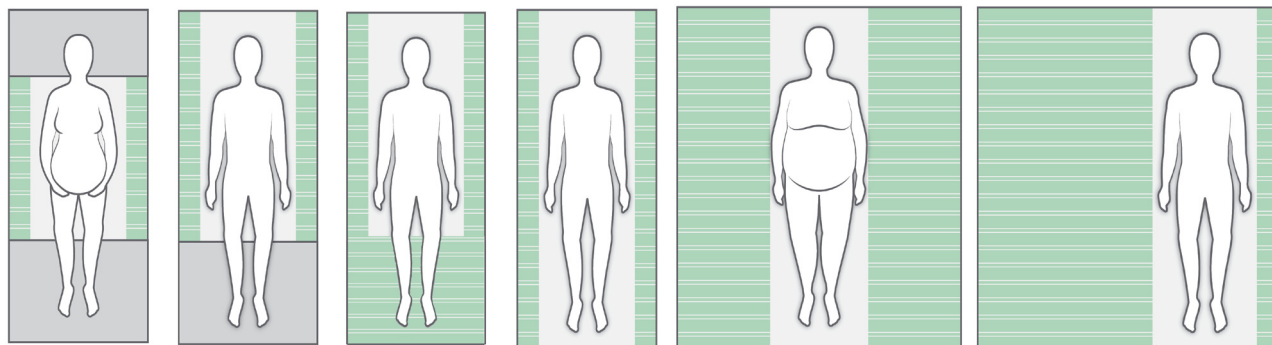

100 x 200 cm

140 x 200 cm

85 x 200 cm

200 x 200 cm

230 x 200 cm

280 x 200 cm

## Positioning different sizes of SatinSheet DrawSheet placed correct on top of SatinSheet 2Direction

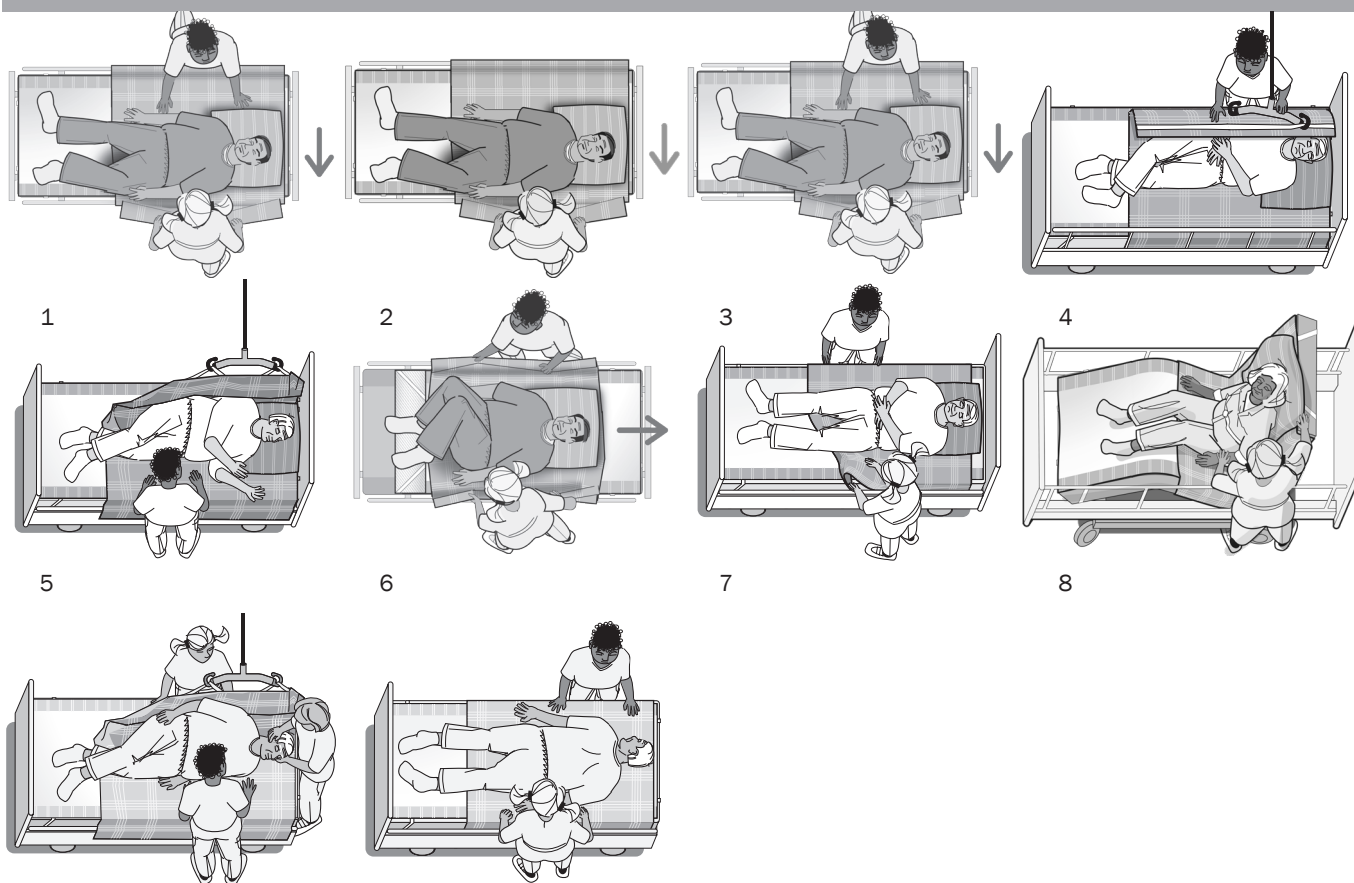
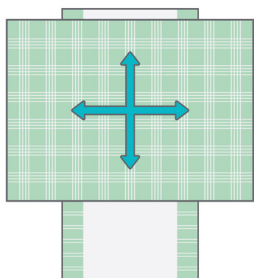

1

2

3

4

5

6

7

8

9

10

## Thank you for choosing an Etac product.

To avoid accidents and injury when moving and handling the products, please read this manual carefully.

The person described as “the user” in this “Instruction for Use” is the person who is lying or sitting on the product. The carers are the people who manoeuvre the product.

 **This symbol appears alongside the text in the manual. It draws the reader’s attention to points at which there may be a risk to the health and safety of the user or carer.**

These products comply with the standards applicable for Class 1 products in the Medical Device Regulation (EU) 2017/745 on medical devices.

At Etac we strive to continually improve our products and therefore we reserve the right to make changes to products without prior warning. All measurements given on illustrations and similar material are for guidance only and Etac cannot be held liable for errors and defects.

The information given in this manual, including recommendations, combinations and sizing, does not apply to special orders and modifications. If the customer makes adjustments, repairs or uses combinations not predetermined by Etac, the Etac CE certification and Etac warranty will not be valid. If in doubt, please contact Etac.



















Warranty: Two-year warranty on material and manufacturing defects, provided that the product is used correctly.

Expected lifetime: The device has an expected service life of 1 to 2 years under normal use. The service life of the device varies depending on usage frequency, loads and how often and how it is washed.

For further information on the Etac Patient handling, see [www.etac.com](http://www.etac.com).

In case of an adverse event occurred in relation to the device, incidents should be reported to your local dealer and the national competent authority in a timely manner. The local dealer will forward information to manufacturer.

## Symbols in general

 Washing	 Disinfect / Wipe off	 Warning	 Manufacturer
 Do not bleach	 Never leave on the floor	 Production year, month and day	 CE-marked
 Tumbledry	 Risk of sliding down	 Batch no./Lot no.	 Keep dry
 Iron	 Keep out of the sun	 User mass limit = maximum rated load	 Non sterile
 Do not dryclean	 Read the user manual	 The product can be scrapped according to national regulations	 Article number
 Medical device			

## Intended purpose

SatinSheet 4Direction is a DrawSheet for use with BaseSheet (SatinSheet BaseSheet 2Direction). The SatinSheet system is used for repositioning and turn a user in bed.

## Intended environment

Acute care, Long-term care, Home care

## Positioning

Position SatinSheet BaseSheet with the low-friction material (satin) uppermost in the middle of the bed (Illustrations). If necessary, a draw sheet can be laid on SatinSheet. All SatinSheet models have a “this side up” label indicating which side of the sheet should face upwards in the bed. An information label, describing the correct use of the product, is sewn into all SatinSheet models/products.

Place SatinSheet 4Direction on BaseSheet (satin against satin).

Before locking the glide system under the mattress, any unevenness/wrinkles should be smoothed to avoid decubitus. The carers pull simultaneously and diagonally from both sides.

## Use

### Turning with SatinSheet 4Direction (Illustrations 1-3)

Always use SatinSheet 4Direction with one of the SatinSheet models.

The back of SatinSheet 4Direction is made of a low-friction material. It is ideal for use with bariatric users. The procedure for turning with SatinSheet 4Direction is identical with the procedure for turning with SatinSheet and a draw sheet. To turn a user in bed: Grasp the draw sheet at hips and shoulders. To achieve a better ergonomic grip, the carer should grasp as much fabric as possible.

Always work with flat wrists and weight transference. Turning with SatinSheet can also be done by two carers. The carers work together. One carer helps pull on SatinSheet while the other carer pulls down on the mattress at the level of the user's hips and shoulders, pushing gently.

If using SatinSheet 4Direction with handles you can turn the user with a hoist. Place the webbing handles on the sling bar hooks and slowly turn the user (Illustrations 4+5). Place a positioning pillow or wedge to support the user's back and slowly lower the hoist again. Remove the handles from the sling bar hooks. Raise the guard rails if required.

Turn the user.

To lock the glide system after turning: Fold the excess material from DrawSheet under the mattress on both sides of the bed.

### Moving the user higher up in the bed (Illustration 6)

To move the user higher up in the bed, grasp SatinSheet 4Direction at both sides of the user's shoulders. Standing with one foot forward, the carer pulls, using weight transference.

### Sitting up in bed with SatinSheet 4Direction (Illustrations 7+8)

To prevent the user sliding down in the bed when sitting up, part

of SatinSheet 4Direction can be folded in under the user. Then fold SatinSheet in under the mattress, although only at the hips. The bed headboard can then be raised. SatinSheet functions here as a brake.

### Prone positioning

Remove the head-end of the bed. If the user is connected to a ventilator or other life saving machines, turn the user towards the equipment. Place the hand of the user under the hip. If needed add 2-3 pillows or positioning cushions used on top of the users body. Place a SatinSheet4Direction on the pillows with the satin facing upwards, starting at the head end - fold the 4Direction away from the users head. Tug the SatinSheet4Direction top around the user like a cocoon. Fold the lower 4Direction away from the users head (satin against satin)

One carer secures the head of the user and one carer on each side to support the user.

Move the user to the opposite side to where the user is turned. Place the webbing handles from the SatinSheet4Direction which the user lay on in the sling bar hooks and slowly turn the user to almost 90° (Illustrations 9) Push and pull in the SatinSheet4direction, to secure the rotation is a bit of center. When user is on the side one carer tug the SatinSheet4Direction on the bed under the user to be able to remove it when the user is turned to prone. Same carer support the user by having the hands on the shoulder. Continue to turn the user until the user is in a proned position. Lower the hoist again. Remove the handles from the sling bar hooks and remove the SatinSheet4Direction. Unfold the 4Direction under the users head. If necessary move the user to the center of the bed. Secure that the user is correct positioned. (illustration 10) Raise the bed rails if required. Turn to supine positioning the same way.

## Special features

Always check the product before use and after washing.

Never use a defective product. If the product shows signs of wear-and-tear, it must be scrapped.

Read these instructions carefully.

It is important that carers receive instruction in manual handling. Etac offers advice and training for carers. For further information, contact Etac.

Always use the correct manual handling techniques

Encourage the user to assist where possible.

To ensure that the user feels safe and that every manual handling is smooth, always plan the manual handling in advance.



There is a risk that the user may slide off. Never leave the user alone on the edge of the bed.



Never leave the product on the floor.



Always conduct a risk assessment, and ensure that the assistive product can be used for the individual user and, in combination with other devices, that it is safe for the user and carers.



It is recommended that the guard rail is in place when the user is left on the glide system, unless a risk assessment has found that the user can be safely left on the glide system without the need of guard rails.



Always lock the glide system when you have completed the transfer.

If in any doubt - please contact Us.

## Material and cleaning

### Material:

SatinSheet 4Direction:

Polycotton: 55% cotton/45% polyester

Satin: Polyester.

SatinSheet In2Sheet 4Direction:

Microfibre top side: Polyester

Middle layer: 65% polyester/35% viscose

Barrier: Polyurethane

Glide area: Polyester

Handles: Nylon

Wings: 55% cotton/45% polyester.

Absorption: 2200 ml/m<sup>2</sup>.

The product should be checked regularly, preferably each time it is used, and especially after washing.

Check that there is no damage to seams or fabric.



**Never try to repair a product yourself.  
Never use a defective product.**



**Recommended to wash the product before use.**

### Washing instructions:

Ironing improves the glide effect.

Do not use fabric softener.

This product can be cleaned with a solvent-free cleaning agent with a pH level between 5 and 9, or a 70% disinfection solution.





Article no.	Product Description	Size (mm)
IM4115S	SatinSheet 4Direction - midi (satin W1470xL1400 mm)	W2000xL1400
IM4115SH	SatinSheet 4Direction w/handles - midi (satin W1470xL1400)	W2000xL1400
IM4121S	SatinSheet 4Direction - maxi (satin W1470xL2000 mm)	W2000xL2000
IM4121SH	SatinSheet 4Direction w/handles - maxi (satin W1470xL2000)	W2000xL2000
IM4131SH	SatinSheet 4Direction w/handles maxi - wide	W3000xL2000
IM4110S	In2Sheet 4Direction w/wings - mini	W850xL900
IM4110SH	In2Sheet 4Direction w/wings + handles - mini	W850xL900
IM4140S	In2Sheet 4Direction w/wings - midi	W1200xL1400
IM4140SH	In2Sheet 4Direction w/wings and handles - midi	W1200xL1400

## Set

Article no.	Description	SatinSheet 2Direction BaseSheet	SatinSheet DrawSheet and SatinSheet 4Direction
IM4200S	SatinSheet DrawSheet midi set	IM4113S SatinSheet 2Direction midi	IM4118S SatinSheet DrawSheet - midi
IM4201S	SatinSheet DrawSheet mini set	IM4108S SatinSheet 2Direction mini	IM4116S SatinSheet DrawSheet - mini
IM4202S	SatinSheet DrawSheet maxi midi set	IM4114S SatinSheet 2Direction maxi	IM4118S SatinSheet DrawSheet - midi
IM4203S	SatinSheet 4Direction Fit midi set	IM4112S SatinSheet 2Direction FIT	IM4115S SatinSheet 4Direction - midi
IM4204S	SatinSheet 4Direction midi set	IM4113S SatinSheet 2Direction midi	IM4115S SatinSheet 4Direction - midi
IM4205S	SatinSheet DrawSheet midi small set	IM4119S SatinSheet 2Direction midi small	IM4118S SatinSheet DrawSheet - midi
IM4207S	SatinSheet 4Direction midi small set	IM4119S SatinSheet 2Direction midi small	IM4115S SatinSheet 4Direction - midi
IM4208S	SatinSheet Corner DrawSheet midi set	IM4107S SatinSheet 2Direction w/elastic	IM4118S SatinSheet DrawSheet - midi
IM4209S	SatinSheet In2Sheet midi mini set	IM4119S SatinSheet 2Direction midi small	IM4110S In2Sheet 4Direction w/wings - mini
IM4210S	SatinSheet In2Sheet mini set	IM4108S SatinSheet 2Direction mini	IM4110S In2Sheet 4Direction w/wings - mini
IM4211S	SatinSheet Corner 4Direction midi set	IM4107S SatinSheet 2Direction w/elastic	IM4115S SatinSheet 4Direction - midi
IM4212S	SatinSheet Corner 4Direction maxi set	IM4107S SatinSheet 2Direction w/elastic	IM4121S SatinSheet 4Direction - maxi
IM4213S	SatinSheet 4Direction maxi set	IM4114S SatinSheet 2Direction maxi	IM4121S SatinSheet 4Direction - maxi
IM4214S	SatinSheet 4Direction maxi set - wide	IM4177S SatinSheet2direction maxi - wide	IM4121S SatinSheet 4Direction - maxi
IM4215S	SatinSheet 4Direction maxi set - double	IM4180S SatinSheet 2Direction maxi - double	IM4121S SatinSheet 4Direction - maxi
IM4216S	SatinSheet 4Direction midi set - wide	IM4176S SatinSheet2direction midi - wide	IM4115S SatinSheet 4Direction - midi
IM4217S	SatinSheet 4Direction midi set - double	IM4179S SatinSheet2direction midi - double	IM4115S SatinSheet 4Direction - midi
IM4218S	SatinSheet 4Direction maxi midi set	IM4114S SatinSheet 2Direction maxi	IM4115S SatinSheet 4Direction - midi
IM4219S	SatinSheet 4Direction maxi midi set - wide	IM4177S SatinSheet2direction maxi - wide	IM4115S SatinSheet 4Direction - midi
IM4220S	SatinSheet 4Direction maxi midi set - double	IM4180S SatinSheet 2Direction maxi - double	IM4115S SatinSheet 4Direction - midi
IM4221S	SatinSheet DrawSheet maxi midi set - wide	IM4177S SatinSheet2direction maxi - wide	IM4118S SatinSheet DrawSheet - midi
IM4222S	SatinSheet DrawSheet maxi midi set - double	IM4180S SatinSheet 2Direction maxi - double	IM4118S SatinSheet DrawSheet - midi
IM4223S	SatinSheet DrawSheet midi set - wide	IM4176S SatinSheet2direction midi - wide	IM4118S SatinSheet DrawSheet - midi
IM4224S	SatinSheet DrawSheet midi set - double	IM4179S SatinSheet2direction midi - double	IM4118S SatinSheet DrawSheet - midi
IM4225S	SatinSheet Corner 4Direction midi set - wide	IM4147S SatinSheet 2Direction w/elastic-wide	IM4115S SatinSheet 4Direction - midi
IM4226S	SatinSheet Corner 4Direction midi set - double	IM4137S SatinSheet 2Direction w/elastic-double	IM4115S SatinSheet 4Direction - midi
IM4227S	SatinSheet Corner DrawSheet midi set - wide	IM4147S SatinSheet 2Direction w/elastic - wide	IM4118S SatinSheet DrawSheet - midi
IM4228S	SatinSheet Corner DrawSheet midi set - double	IM4137S SatinSheet 2Direction w/elastic-double	IM4118S SatinSheet DrawSheet - midi
IM4229S	SatinSheet Corner 4Direction maxi set - wide	IM4147S SatinSheet 2Direction w/elastic - wide	IM4121S SatinSheet 4Direction - maxi
IM4230S	SatinSheet Corner 4Direction maxi set - double	IM4137S SatinSheet 2Direction w/elastic - double	IM4121S SatinSheet 4Direction - maxi
IM4231S	SatinSheet Corner 4Direction w/handle midi set	IM4107S SatinSheet 2Direction w/elastic	IM4115SH SatinSheet 4Direction w/handles- midi
IM4251S	SatinSheet 4Direction maxi midi set - small		

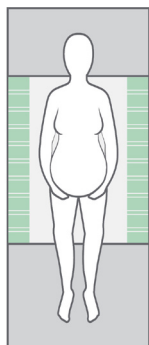

Article no.	BaseSheet - Mini
IM4133S	SatinSheet 2Direction mini - small
IM4108S	SatinSheet 2Direction mini
IM4175S	SatinSheet 2Direction mini - wide
IM4178S	SatinSheet 2Direction mini - double

**BaseSheet - Mini can be combined with:**

Article no.	DrawSheet, 4Direction and PillowCase
IM4116S	SatinSheet drawSheet - mini
IM4110S	In2Sheet 4Direction w/wings - mini
IM4110SH	In2Sheet 4Direction w/wings + handles - mini
IM4117S	SatinSheet 2Direction PillowCase

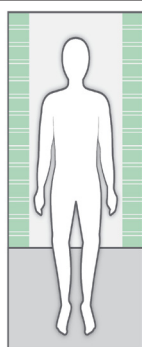

Article no.	BaseSheet - Midi
IM4119S	SatinSheet 2Direction midi small
IM4113S	SatinSheet 2Direction midi
IM4176S	SatinSheet 2Direction midi - wide
IM4179S	SatinSheet 2Direction midi - double

**BaseSheet - Midi can be combined with:**

Article no.	DrawSheet, 4Direction and PillowCase
IM4118S	SatinSheet DrawSheet - midi
IM4115S	SatinSheet 4Direction - midi
IM4115SH	SatinSheet 4Direction w/handles - midi
IM4121S	SatinSheet 4Direction - maxi
IM4121SH	SatinSheet 4Direction w/handles - maxi
IM4117S	SatinSheet 2Direction PillowCase

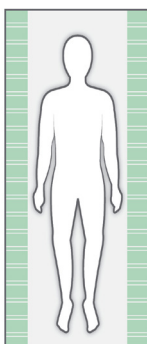

Article no.	BaseSheet - Maxi
IM4181S	SatinSheet 2Direction maxi - small
IM4114S	SatinSheet 2Direction maxi
IM4177SH	SatinSheet 2Direction maxi - wide
IM4180S	SatinSheet 2Direction maxi - double
IM4122S	SatinSheet 2Direction 180cm bed

Article no.	BaseSheet - Maxi Corner
IM4107S	SatinSheet 2Direction Corner
IM4147S	SatinSheet 2Direction Corner - wide
IM4137S	SatinSheet 2Direction Corner - double

Article no.	BaseSheet - Maxi Fit
IM4112S	SatinSheet 2Direction Fit
IM4142S	SatinSheet 2Direction Elastic Fit

Article no.	BaseSheet - Mini, Midi and Maxi Corner
IM4167S	SatinSheet 2Direction Corner - small -mini
IM4157S	SatinSheet 2Direction Corner - midi
IM4197S	SatinSheet 2Direction Corner - double - double - maxi

**BaseSheet - Maxi/Corner/Fit can be combined with:**

Article no.	4Direction and In2Sheet 4Direction
M4115S	SatinSheet 4Direction - midi
IM4115SH	SatinSheet 4Direction w/handles - midi
IM4140S	In2Sheet 4Direction w/wings - midi
IM4140SH	In2Sheet 4Direction - w/wings + handles - midi
IM4121S	SatinSheet 4Direction - maxi
IM4121SH	SatinSheet 4Direction w/handles - maxi

**Remember SatinSheet PillowCase (2D)**

IM4117S	SatinSheet 2Direction PillowCase
---------	----------------------------------



## Inspection

### First inspection:

- Is the packaging intact?
- Read the label on the packaging and check the article no. and product description
- Check that Short Instruction is enclosed – updated User Manual/Instruction for use can be downloaded from [www.etac.com](http://www.etac.com) or contact your Etac Customer Service or the local dealer.
- Check the label on the product - does it include article no., product description, lot/batch no., cleaning instructions and supplier name?

### Periodic Inspection:

- Make sure that your Manual transfer system always is in a perfect condition.
- After wash – always check materials, stitching, handles, buckles.
- If the product shows signs of wear and tear, it must be removed from service immediately.



#### Visual inspection/Check the product:

Ensure that the materials, seams, stitching, handles, buckles are intact/faultless.



#### Stability test:

Try to bend the product verify that it feels firm, stable and solid.

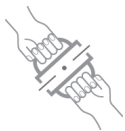

#### Mechanical load or stress/Test handles:

Draw hard in the handles in opposite directions and control the material, seams and stitching.

Test buckles:

Lock the buckle and draw in opposite directions, control the buckle and the stitching.



#### Test low/high friction:

Place the product on a firm surface or a bed, place your hands on the material and test the friction by pushing your hands down into the product.

Low friction – slides effortlessly

High friction – no sliding/moving

### Check:

Manual transfer aids with handles, straps and buckles:



Manual transfer aids with for sitting and lying transfer and with high or low friction:



Production year, month and day



The product can be scrapped in accordance with national regulations



Read the user manual



## Special Products and Service

### **Contact Us**

Units 5 and 6 Lower Vicarage Road Southampton  
Hampshire  
SO19 7RJ  
T: 02380 420678  
E: [info@easycare systems.co.uk](mailto:info@easycare systems.co.uk)

[www.easycare systems.co.uk](http://www.easycare systems.co.uk)