



Special Products and Service

General User/ Safety Guide

# **WOBURN ULTIMATE PROFILING BEDS V3 1200/1400**

PROFILING BEDS



[www.easycare systems.co.uk](http://www.easycare systems.co.uk)



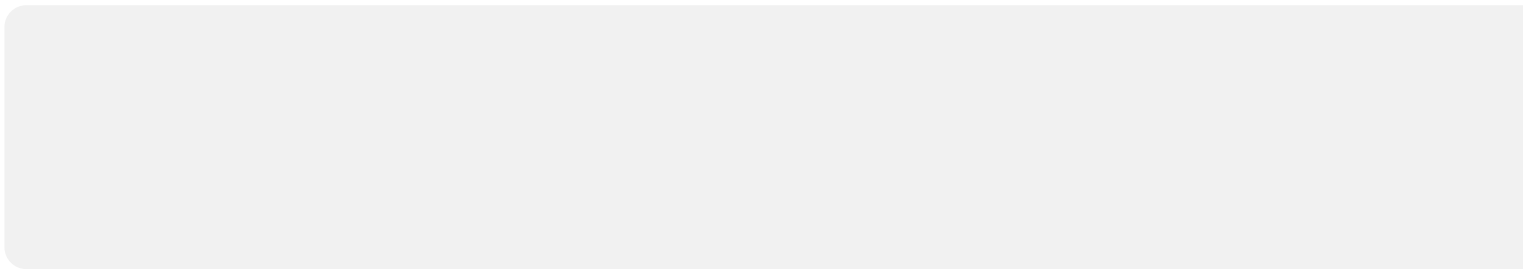

# CONTENTS

	<b>FOREWORD</b>	<b>5</b>
<b>1</b>	<b>GENERAL INFORMATION</b>	<b>6</b>
1.1	- Explanation of the Symbols Used	<b>6</b>
1.2	- Definition of the Groups of Persons involved	<b>7</b>
<b>2</b>	<b>Intended Purpose</b>	<b>8</b>
2.1	- Use for the Purpose Intended (Application environment)	<b>8</b>
2.2	- Non-compliant Use	<b>8</b>
<b>3</b>	<b>General Regulations for Users</b>	<b>9</b>
3.1	- Qualification of Users	<b>9</b>
<b>4</b>	<b>Safety Instructions</b>	<b>9</b>
4.1	- General Safety Instructions	<b>9</b>
4.2	- Safety Information for the Operator	<b>11</b>
4.3	- Safety Information for the User	<b>11</b>
4.4	- Cleaning and Disinfection	<b>12</b>
4.5	- Servicing and Maintenance	<b>12</b>
4.6	- Accessories	<b>13</b>
4.7	- Electromagnetic Compatibility	<b>13</b>
4.8	- Transport and Storage	<b>13</b>
4.9	- Service Life and Disposal	<b>13</b>
<b>5</b>	<b>PRE-INSTALLATION CHECK</b>	<b>14</b>
<b>6</b>	<b>INSTALLATION AND COMMISSIONING</b>	<b>15</b>
6.1	- Removal from the Transporting Device	<b>15</b>
6.2	- Assembly of the Care Bed	<b>17</b>
6.3	- Connecting the Care Bed to the Mains Supply	<b>22</b>
6.4	- Placing into service	<b>23</b>
6.5	- Disassembly of the Care Bed	<b>23</b>
<b>7</b>	<b>DESCRIPTION OF FUNCTIONS</b>	<b>24</b>
7.1	- Bed Overview	<b>24</b>
7.2	- Handset with Locking Function	<b>25</b>
7.3	- Locking Function for Handset	<b>25</b>
7.4	- Operation of the Side Rails	<b>26</b>
7.5	- Operation of the Castors	<b>26</b>
7.6	- Electric Emergency Lowering via the Integrated 9V Battery	<b>27</b>
7.6.1	- Position and Principle of Operation	<b>27</b>
7.6.2	- Battery Change	<b>27</b>
<b>8</b>	<b>CARE, CLEANING &amp; DISINFECTION</b>	<b>28</b>
<b>9</b>	<b>TROUBLE SHOOTING</b>	<b>28</b>

# CONTENTS

<b>10</b>	<b>SERVICING</b>	<b>29</b>
10.1	- Principles	<b>29</b>
10.2	- List of Technical Safety Checks according to EN 62353	<b>30</b>
10.3	- Checking the Initial Fault Safety by means of the Integrated Control Box in the Handset	<b>32</b>
10.4	- Measurement of Overall Electrical System	<b>32</b>
<b>11</b>	<b>GUARANTEE</b>	<b>33</b>
<b>12</b>	<b>SERVICE LIFE &amp; DISPOSAL</b>	<b>33</b>
<b>13</b>	<b>TECHNICAL SPECIFICATION</b>	<b>34</b>
13.1	- Technical Data (Mechanical)	<b>34</b>
13.2	- Technical Data (Electric)	<b>34</b>
13.3	- Technical Data (Surroundings)	<b>35</b>
13.4	- Classification	<b>35</b>
13.5	- Weights of the Individual Components	<b>35</b>
13.6	- Type Plate	<b>35</b>
13.7	- Information about electromagnetic emissions	<b>36</b>
13.8	- Labels	<b>40</b>
<b>14</b>	<b>DATE OF PURCHASE</b>	<b>41</b>
		<b>42</b>

# CAUTIONS & WARNINGS



**READ THIS INSTRUCTION MANUAL AND OBSERVE SAFETY INSTRUCTIONS.**



## **CAUTION**

Please read and observe this instruction manual before each use. In the event that the care bed changes owners, please supply this instruction manual to the new owner.

When the bed is moved on the transport frame take care not to allow it to overbalance. The narrow, tall design saves storage space but may tip over if handled carelessly.

Please check all fixings on your bed at least once a month. Pay special attention to sleeping platform connections.

Before cleaning and disinfecting, the mains plug must be disconnected and hung up safely. Plugs for the handset and the motors which are inserted into the mattress base control box and the motor unit must remain plugged in. This is necessary to prevent water ingress to the control box.

Do not sit on the leg section of the bed when operating the raise function.

Ensure that the recommended service and maintenance schedule in this manual is completed. Failure to do so could invalidate warranty claims.

# GENERAL INFORMATION

## 1 GENERAL INFORMATION



### BEFORE USING THIS SYSTEM FOR THE FIRST TIME:

- **Read through this instruction manual conscientiously from start to finish.**
- **Please observe the various safety instructions.**

**Clean and disinfect the care bed before first use**

Harvest Healthcare care beds bear the CE mark and meet all safety and functionality requirements. This bed was tested according to the international standards which contain the safety requirements for medical products. These safety requirements can only be met however, if the user satisfies himself of the proper state of the care bed (including accessories) before using the bed.

Please observe the legislation in your country.

### 1.1 EXPLANATION OF THE SYMBOLS USED



Read information with this symbol carefully and follow instructions. This information is safety-relevant.



This symbol indicates hazards due to electrical voltage. There is mortal danger!



This symbol indicates general hazards. There is danger to life and health.



Conformity mark in accordance with the Medical Device Directive (93/42 EEC).

**IPX4**

The electrical equipment is splash-proof.



Symbol for Protection Class II device, double shock-proof



Symbol for type B device according to DIN EN 60601-1.



Medical Device

# GENERAL INFORMATION

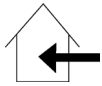

This care bed may only be used indoors



This product must be disposed of in a separate refuse collection in the European Union. Do not dispose of as normal domestic waste.



Symbol for direct current.



Symbol for alternating current.



Maximum permissible load.



Maximum patient weight.

## 1.2 DEFINITION OF THE GROUPS INVOLVED

### OPERATOR

An operator is any natural or legal person who uses the care bed or on whose instruction it is used (e.g. nursing homes, specialised retailers, health insurance companies, medical suppliers).

### USERS

Users are persons who as a result of their vocational training, experience or briefing are authorised to operate the care bed or to carry out work on it, or are instructed in handling the bed. Furthermore the user can recognise and avoid potential dangers and assess the clinical condition of the patient.

### PATIENT / OCCUPANT

Persons in need of care, handicapped or infirm and occupying a care bed.

### QUALIFIED PERSONNEL

Qualified personnel are employees of the operator who as a result of their vocational training or briefing are entitled to deliver, assemble, disassemble and transport the care bed. In addition, these persons are instructed in the cleaning and disinfection regulations for the care bed.



**If any serious incident occurs in connection with the Woburn bed range, you must report it to Manufacturer TekVor Care GmbH and or the responsible Health Authority as well as Harvest Healthcare Ltd.**

# GENERAL INFORMATION

## 2 INTENDED PURPOSE

### 2.1 USE ONLY FOR THE PURPOSE INTENDED (APPLICATION ENVIRONMENT)

This care bed is intended for accommodating patients or occupants (height and mass  $\geq 150$  cm and max. **300kg**) in residential homes, nursing homes and in care in the home (application environments 3 and 4) and may only be used under the conditions for use described in this Instruction Manual. It is used to alleviate or compensate for handicaps or disabilities and to facilitate the working conditions for the carer.

Any other use shall be regarded as non-compliant with the regulations and is excluded from any liability.

**ATTENTION: The care bed is not designed for use in hospitals.**

The care bed is not suitable for medical electrical applications which involve intravascular or intercardiac processes with the patient.

The care bed is not designed for the transport of patients.

Under certain conditions the care bed can be used for other medical purposes with medical appliances such as antidecubitus mattresses, aerators, alimentation systems etc. In this case all bed functions must be locked out with the nurse key on the handset for safety. The medical appliance providers are liable for the compliance of the device with the directives of IEC 60601-1-1.

If other electrical devices are used on the bed and to prevent the risk of an electrical shock, protective measures and precautions must be established to prevent power cords from being trapped and squeezed in moving parts of the bed.

### 2.2 NON-INTENDED USE

All uses deviating from the intended purpose, which may also be hazardous as a result. This includes for example:

- Loading the care bed beyond the safe admissible working load (see section **13.1** and identity label on bed frame).
- Operation of the care bed by patients or occupants who have not been instructed in its use.
- Use of the bed for small adults and children (less than **150 cm** and greater than **300kg**).
- Attempting to move the care bed when it is in a braked position.
- Use of the care bed on a non-horizontal surface (max. incline 5°).



# GENERAL INFORMATION

## 3 GENERAL REGULATIONS FOR USERS

The care bed must only be used for the purpose intended. When setting up, operating and using the care bed, respect the regulations in your country and the general recognised rules of technology and the occupational health and safety and accident prevention regulations.

If the care bed is in a faulty state, in which the patient/occupant, care personnel or third persons could be endangered, operation may not be started.

### 3.1 QUALIFICATION OF USERS

The care bed may only be operated by persons who have the corresponding training or experience to enable them to handle the care bed correctly.

## 4 SAFETY INSTRUCTIONS

### 4.1 GENERAL SAFETY INSTRUCTIONS



**Never store anything under the bed.**

Ensure that children do not operate the control system and ensure no pets are under the bed before operating any of the functions.

Do not sit on the leg section of the bed when operating the raise function.



During the briefing, specific attention must be drawn to any potential dangers which can occur despite correct operation. Before putting the care bed into service for the first time, the Instruction Manual must be read conscientiously and in detail by the user / care personnel.



When operating the adjusting functions, there must not be any objects or people's limbs in the plane of movement of the care bed. **Risk of crushing.**



If the physical or mental state of the patient requires, the handset should be locked on the reverse side when not in use (nurses' key). See detailed description of the locking operation at section **7.2 & 7.3**. (It may be advisable to keep the handset out of reach of such a patient to avoid the risk of strangulation with the handset cord).



Adjustments to the bed must only be carried out by suitably instructed persons or in the presence of an instructed person.

# GENERAL INFORMATION



Unplug the mains plug from the socket before moving the care bed and take care to avoid dragging the mains plug across the floor when moving the bed.



The mains plug must always remain accessible to enable immediate cut-off by unplugging the mains plug from the wall socket in case of emergency. The mains cable must be free and not caught in anything, as it gets carried along when the bed height is adjusted. Otherwise, the mains cable may be torn out and damaged. In addition, the mains plug may be pulled out of its socket and electric leads exposed as a result. If the mains cable or the mains plug are damaged, the relevant part must be replaced. This work should only be carried out by the manufacturer or authorised professionals.



When connecting the mains plug do not use multiple sockets as liquids may penetrate into these (fire hazard and electric shock).



**Before cleaning and disinfection the mains plug must be unplugged and hung up safely. Plugs for the handset and the motors which are inserted into the mattress base control box and motor unit must remain plugged in. This is necessary to prevent water ingress into the control box.**



When the bed is stationary the castors must always be in the braked position. If the castors are not braked, the bed can move when the occupant gets into and out of bed, since the occupant uses the bed for support. Injury can result if the care bed rolls away.



In order to move the care bed, the brakes on all four castors must be released and the mattress base be adjusted to the lowest horizontal position.



The maximum duty cycle and the safe working load must not be exceeded otherwise safe operation cannot be guaranteed (please refer to the Technical Data in section **13**).



The bed must not be used in rooms where there is a risk of explosion.



The bed must only be taken apart if there is no patient or occupant in it.

# GENERAL INFORMATION

## 4.2 SAFETY INFORMATION FOR THE OPERATOR



With the help of this Instruction Manual, instruct each user in the safe operation of this care bed before it is put into service for the first time.

Advise the user of any hazards which may occur if not handled correctly.

Only persons who have been properly instructed may operate this care bed. This also applies to persons who only operate the care bed on a temporary basis.

According to the Medical Products Act (German abbreviation: MPG, Medizinproduktgesetz), care beds are Class I active medical products.

Please observe your obligations as the operator in accordance with the Operators of Medical Products Ordinance (Medizinprodukte-Betreiberverordnung, German abbreviation: MPBetreibV), in order to ensure the permanently safe operation of this medical product with no risk of danger to patients, users or third parties. If the care bed is used on a long-term basis, checks for proper functioning and for any visible damage must be performed and documented at least once a year. See section **10.2**.

## 4.3 SAFETY INFORMATION FOR THE USER

Ensure that the operator instructs you in the safe operation of this bed.

In addition, pay particular attention to the general safety information in **4.1**. Adjustments of the bed must only be carried out by suitably instructed persons or in the presence of an instructed person.

Make sure that the mattress base has travelled to its lowest position before leaving the patient unattended. This will minimise the risk of injury to the patient when getting in or out of bed.

If there is a suspected fault or damage, unplug the mains plug from the socket. Clearly mark the care bed as "Out of Order" and take it out of service immediately. Please inform the person in charge without delay.

# GENERAL INFORMATION

## 4.4 CLEANING & DISINFECTION



**Before cleaning and disinfection the mains plug must be unplugged and hung up safely. Plugs for the handset and the motors that are plugged into the control box must remain in their sockets. This is necessary to prevent water from getting into the control system.**



Do not immerse electrical components in water but wipe with a damp cloth. The electrical components must not be cleaned with a high pressure cleaner or a water jet! Only disinfection by wiping is allowed.



Always wear waterproof gloves when cleaning and disinfecting to avoid skin irritation.



Attention: In the event of disinfection by spraying on a large scale with products containing alcohol there is a danger of explosion and fire.

## 4.5 SERVICING & MAINTENANCE



Servicing work must only be carried out by persons who have at least read the safety regulations and are qualified according to the MPBetreibV (Operators of Medical Products Ordinance) § 4 and 6.



**A technical check and/or safety inspection must be conducted at least once a year and after a lengthy break in use and before each further use. See section 10.2.**



Any defects, damage or signs of wear must be rectified without delay. Only original spare parts from Harvest Healthcare Ltd may be used, otherwise all guarantees or warranties will be excluded.



The 9V block battery is the energy store for electrical emergency lowering in the event of a power failure. The energy store is sufficient for one emergency lowering only and must then be replaced. If the expiry date of the battery has elapsed then it should be replaced immediately. Since batteries are subject to self-discharging, it is recommended that the battery is replaced every two years if not used. Ensure that it is a type 6LR61 alkaline manganese battery and not any other type. Used batteries must be disposed of in an environmentally compatible way.

**Please check all fixings on your bed at least once a month. Pay special attention to sleeping platform connections.**

# GENERAL INFORMATION

## 4.6 ACCESSORIES

The optional accessories available include a patient lifting pole of which the safe working load of 80 kg **must not be exceeded**. The lifting pole may only be used within its admissible adjusting range which is defined by the sleeve on the bed. Otherwise the bed may tip and result in serious injury.

## 4.7 ELECTROMAGNETIC COMPATIBILITY

Regarding their emitted interference and interference resistance the electric motor units comply with the requirements of EN 60601-1-2:2007 (see section **13.7**), but it is possible that electrical devices interfere with each other. In this case switch off the care bed for a short time or remove the interference source. We refer to the paper of the BfArM reference n° 9/0508 (Bundesinstitut für Arzneimittel und Medizinprodukte).

## 4.8 TRANSPORT & STORAGE

The care bed can be easily transported. On the transport device provided it can be manoeuvred in very small spaces on the bed's castors.

If the bed is stored for a lengthy period, the 9V block battery should be removed, otherwise it will discharge.



**State as delivered  
(in cover)**



**Care bed on the  
transport device**



**When the bed is moved on the transport frame take care not to allow it to over-balance. The narrow, tall design saves storage space but may tip over if handled carelessly.**

## 4.9 SERVICE LIFE & DISPOSAL



The normal service life for care beds in domestic use is approximately 5 years. The care bed must not be disposed of as normal domestic waste after its service life has expired. To ensure that it is disposed of in an environmentally compatible way please contact Harvest Healthcare Ltd.

# INSTALLATION

## 5 PRE-INSTALLATION CHECK



After unpacking check the following parts are present:

- |          |   |          |  |
|----------|---|----------|--|
| <b>A</b> | Backrest section with mounted backrest actuator and control box   | <b>E</b> | 6 pcs. aluminium sideguards with 12 plastic end caps (end caps supplied attached to the bed's base section). |
| <b>B</b> | Legrest section with mounted kneebreak actuator                   | <b>F</b> | 12 plastic end caps (end caps supplied attached to the bed's base section).                                  |
| <b>C</b> | 2x height adjustable bed ends with mounted actuators and castors. | <b>G</b> | Handset with locking device  |
| <b>D</b> | Power supply with cord and plug                                   | <b>H</b> | (Optional) Lifting pole with triangle grip and strap   |
|          |   | <b>I</b> | triangle grip and strap  |



**On delivery and before installation check that the packaging is undamaged. Report any visible damage to the transport company immediately.**

# INSTALLATION

## 6 INSTALLATION & COMMISSIONING



Harvest Healthcare Ltd recommends a risk assessment is completed by the Operator before this bed is assembled.

### 6.1 REMOVAL FROM THE TRANSPORT DEVICE

Lift the cover from the bed unit and transporting device.  
Please do not dispose of the cover.  
It can be used again as a dust cover in the event that the care bed is later stored in the transport device.



Bed as delivered



Care bed on transport device

Lift mattress platform sections from the transport system



To prevent the risk of finger trapping lift each mattress base from the metal platform crossbar (as shown). Do not lift from the outside of the frame.

# INSTALLATION

Remove the height-adjustable head and foot end panels from the transporting device. To do this, release the spring-loaded catches that are later used to fix the height-adjustable head and foot end panels to the mattress base.



Pull out and turn through 90°



Backrest Section

Legrest Section

Backrest Actuator



Kneebreak Actuator

Control Box

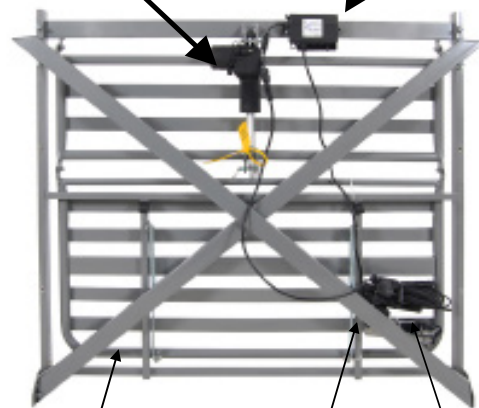

Support Bars

SMPS

Handset

Remove the cable tie from the support bars, mains adapter and handset.



Mains cable

Handset





# INSTALLATION

## 6.2 ASSEMBLY OF THE CARE BED

Connecting the two halves of the mattress platform.

Now fit the two halves of the mattress platform together and tighten the four Allen cap screws (two on each side).



After the two platform halves are fixed together, the two platform support bars (one on each side) have to be fitted to the outer edge of the underside of the mattress platform. The support bars should be fitted with the platform face down on the floor. The support bars will align with the fixtures on the bottom of the mattress platform. If the support bars do not align, rotate the support bars by 180 degrees.



Attach the two support bars (as shown in the images above) using the 8 M8 Allen bolts provided with the bed (four on each side of the bed).



**Harvest Healthcare recommends installing support bars and the Allen bolts with the platform face down to prevent damage to the threads in the mattress section.**

**NEVER USE THE BED WITHOUT THE SUPPORT BARS INSTALLED.**

# INSTALLATION

## Assembling and connecting the motors.

The kneebrake motor is supplied in transport position. To use this function, the motor must be moved into the operational position.



Failure to connect the motors correctly will result in damage to the motor and/ or sleeping platform.

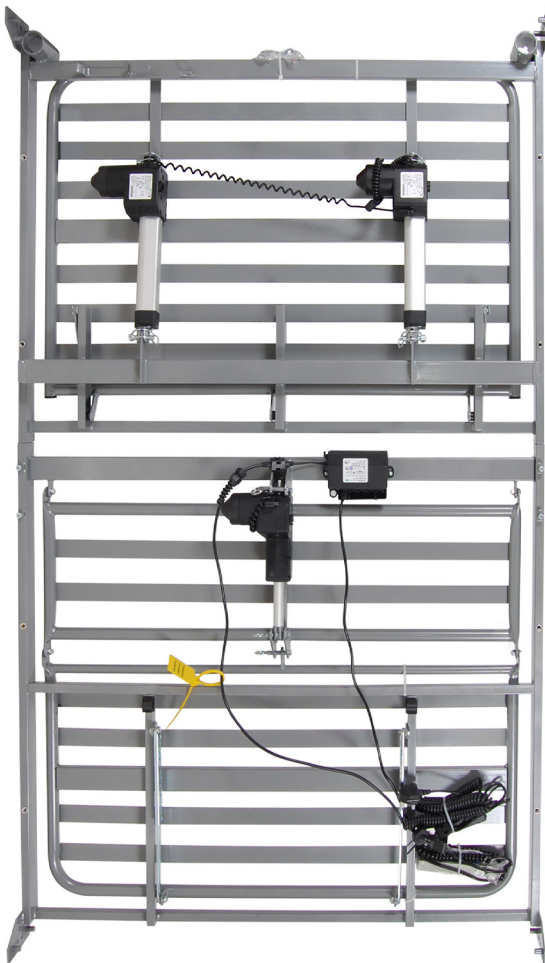

Image below shows the motor in transport position.



Remove the locking pin, lift the motor into position and re secure the locking pin.



The Woburn Ultimate 1400 is supplied with two knee brake motors. Repeat this process for both.

(To re fit the bed onto the trasport brackets (after use) you will need to return the knee break motors back into the transport position.)

# INSTALLATION

## Fixing the mattress base to the bed ends.

Lay the mattress platform on the floor. To attach the first of the bed ends to the mattress base, lift the platform and slot the mounting lugs into the brackets.

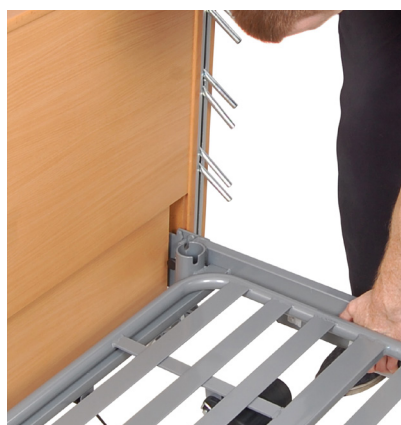
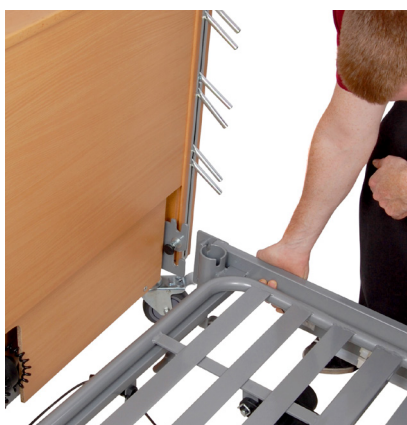

When securing the spring-loaded catches, ensure that the bolt locks into place in the hole provided for it.



Mounting lugs for the mattress base

Spring-loaded catches



The bolt of the spring-loaded catch must be securely latched into the hole

When securing the spring-loaded catches, ensure that the bolt locks securely into place.

Now slot the mattress base into place on the second bed-end panel at the other end of the bed.



Ensure all four spring-loaded catches are secure.

# INSTALLATION

## Fitting the side guards.

Raise all side guard fingers to the top position.

Slide the six side guards onto the side rail fingers at one end of the bed, resting the opposite end on the floor.



Lift one corner of the mattress base off the mounting lug and pull the mattress base back far enough to allow you to push the side guards onto the siderail fingers.

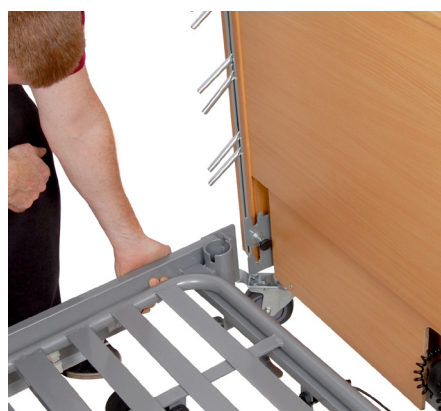

Lift one corner of the mattress base slightly. Pull back the bed end panel with mounting lug



Slide the side guards onto the side rail fingers.



Fix the mounting lug back into position and secure the spring-loaded catches.

With the side guards slotted into place, the end panel can be pushed back up to the mattress base and secured with the mounting lug.

Repeat this procedure on the other side of the bed with the remaining three side guards and then fix the two spring-loaded catches securely to the mattress base.



Ensure all four spring-loaded catches are secure.

The side rails can be locked out of use.

To engage the Lockdown function, lower the side rails and tighten the fixing below the top rail.

The top rail will lift slightly but cannot be lifted to engage the side rails. To reengage the side rails simply loosen the fixing.



# INSTALLATION

## Folding Mattress Guides



The bed has folding mattress guides. It is important that the mattress guides are moved from the “transport position” into the “in use position” before the bed is put in use.

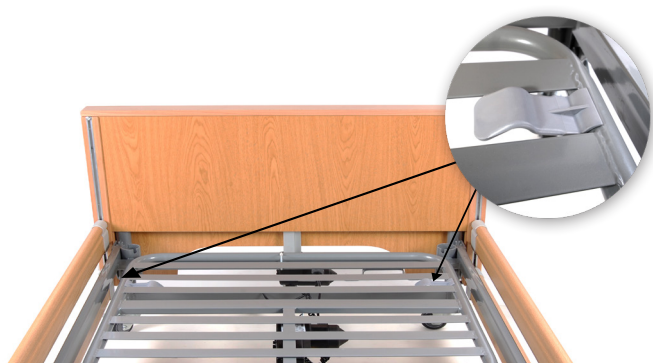

Mattress guides in transport position

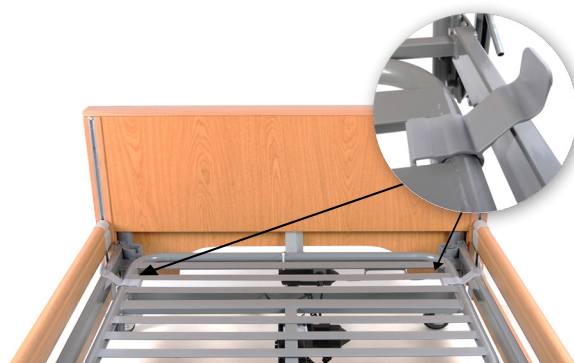

Mattress guides in the in use position

Connecting the height adjustment motors and the thigh rest adjustment motor to the mains power supply.

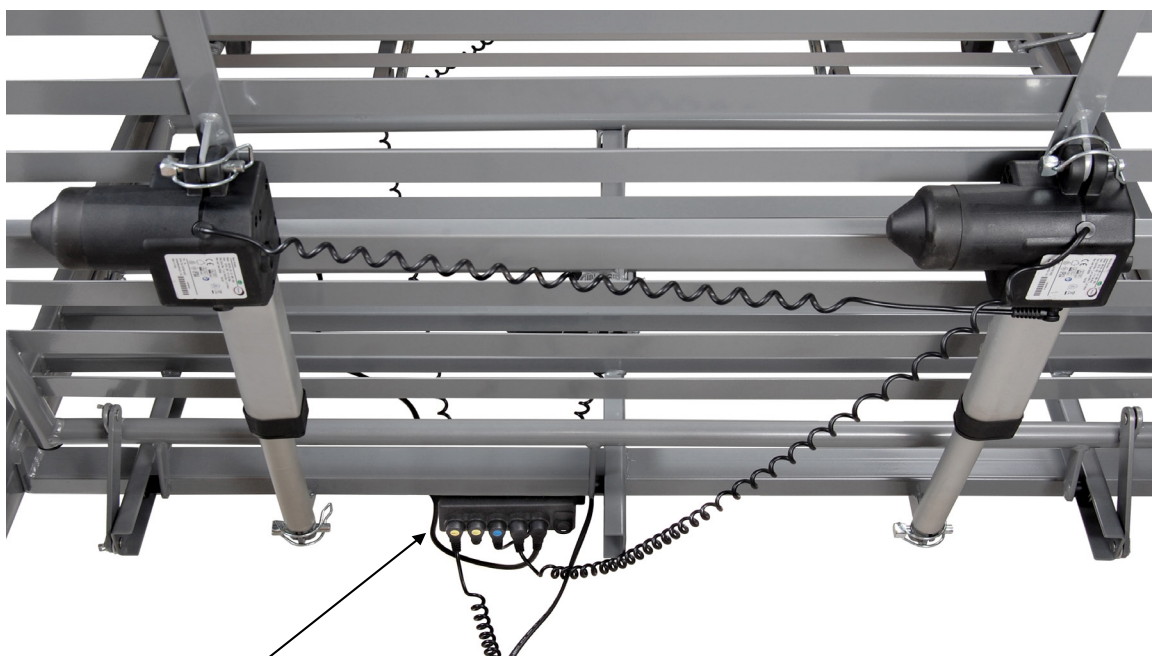

Motor 1 plugs into the control box, Motor 2 plugs into motor 1.

# INSTALLATION

The power cables for the height adjustment motors are wound round its housing. The Backrest motor is supplied already plugged in.



Unwind the cable of the electric motor.

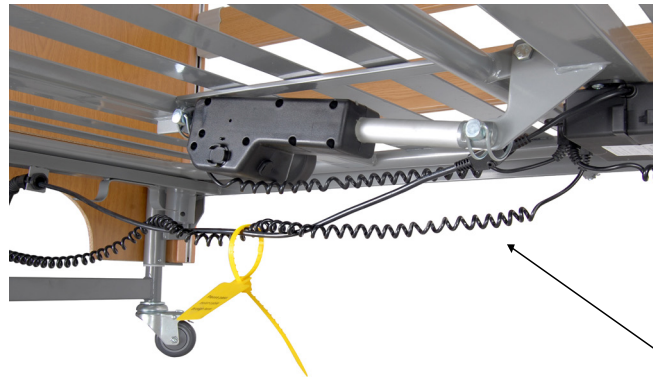

Headboard motor cable wraps around the power supply cable from the control box to keep the cable off the floor.

The foot-board motor cable should be supported with one of the clips on the underside of the bed

Remove the plug cover by unscrewing the two fixing screws.

After you have inserted all the plugs into the correct sockets, screw the plug cover back onto the power supply unit housing.

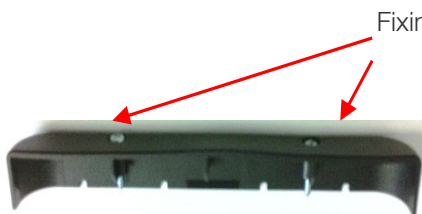

Fixing Screws

Height adjustment adjustment Thigh and backrest adjustments

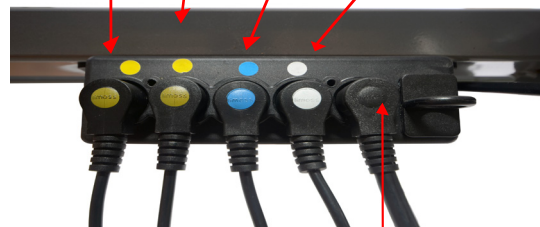

handset and power supply are supplied already plugged in



You may now remove the transportation safety ties from the mattress base by cutting through the cable ties with a side cutter or a knife.

# INSTALLATION

Connecting the bed to the mains socket.

Unwind the mains cable under the mattress base.

Bracket for winding up the mains cable

Unwind the mains cable



Strain relief for mains cable



Plug the mains plug into the socket. The mains plug must always remain accessible to enable immediate cut-off by unplugging the mains plug from the wall socket in case of emergency.

The electrical adjustment motors are now ready for use.

## 6.3 PLACING INTO SERVICE

Make sure that all assembly steps have been carried out according to chapter 6, section 6.1 and 6.2. Carry out a safety check according to chapter 10, section 10.2 after assembly. Clean and disinfect the bed as described in chapter 8 before putting into service and before each further use.

## 6.4 DISASSEMBLY OF THE CARE BED

Unplug the mains plug from the socket before disassembly. Disassembly of the care bed is carried out in reverse order of assembly.

# INSTALLATION

## 7 DESCRIPTION OF FUNCTION

### 7.1 BED OVERVIEW

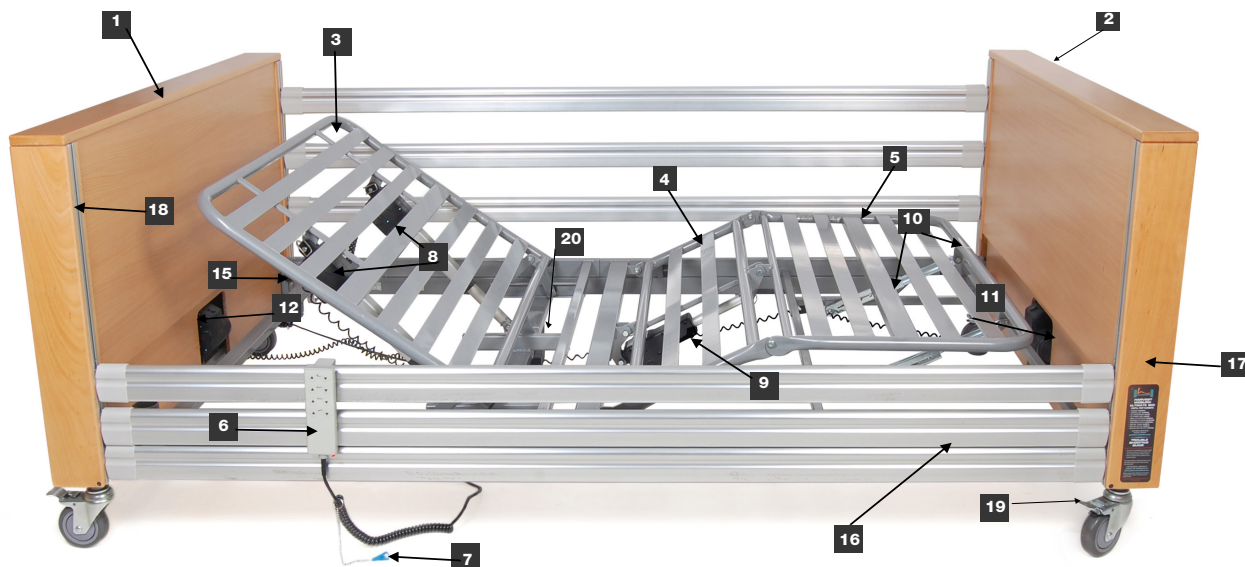

- 1 Head end with integrated height adjustment
- 2 Foot end with integrated height adjustment
- 3 Electrically adjustable backrest
- 4 Electrically adjustable thigh rest
- 5 Mechanically adjustable leg rest
- 6 Handset
- 7 Nurses' locking key
- 8 Electric motor unit for backrest
- 9 Electric motor unit for thigh rest
- 10 Mechanical catch fitting for adjusting leg rest
- 11 Electric height adjustment motor at foot end
- 12 Electric height adjustment motor at head end
- 13 Coiled cable with SMPS (transformer) and main cable with power plug
- 14 Folding mattress guide
- 15 Locating sleeve for patient's lifting pole (as an option)
- 16 Side rail (with end caps)
- 17 Side rail catch
- 18 Side guard channel
- 19 Castor with mechanical brake
- 20 Control unit

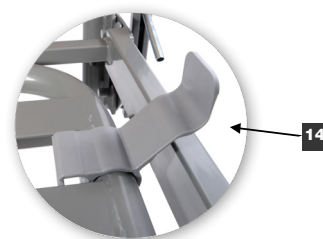



# INSTALLATION

## 7.2 HANDSET WITH LOCKING FUNCTION

The motorised bed functions can be operated via the handset. All functions can be locked with the nurses' key

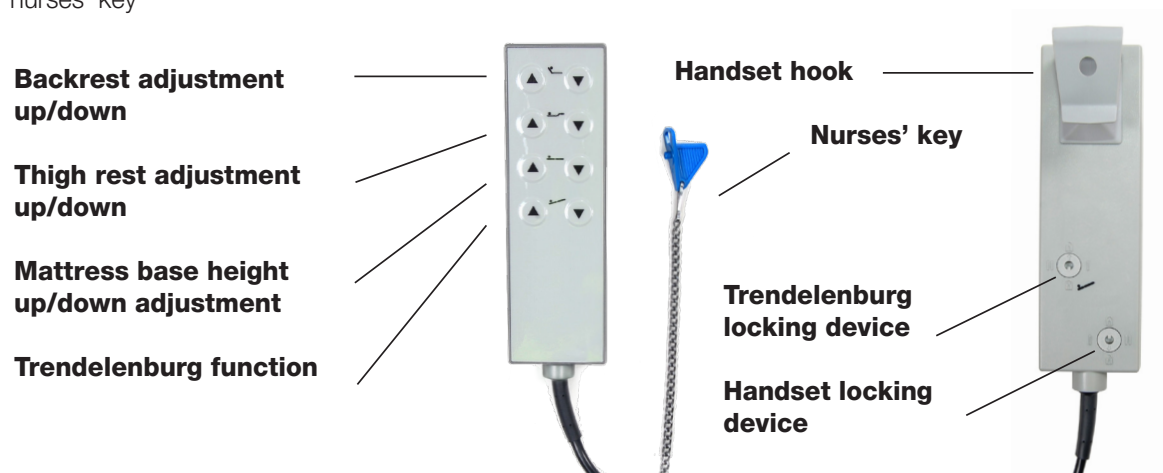

To avoid damage, the handset should always be hung up by the handset hook (e.g. on mattress base) when not in use.



**Press only one button at a time, as the system could overload and become damaged.**

## 7.3 LOCKING FUNCTION FOR THE HANDSET

On the back of the handset is a locking device. All electric adjustment functions can be blocked at the same time using the nurses' key supplied.

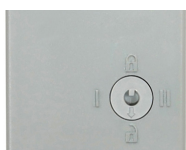

**All electric adjustment functions released**



**All electric adjustment functions locked**



The switching positions I and II are testing settings, used to check the safety during the annual inspection or after repair work, or each time the bed is put into service again.

# OPERATION

## 7.4 OPERATION OF THE SIDE GUARDS

To use the side guards, lift the upper side guard until it locks into place in the highest position. To lower the side guard, lift the upper side guard and at the same time push the release button for the side guard lock and lower the side guard.

**If the side guard is in its highest position, ensure that it is always safely locked into place. The side rail guards are designed only to prevent a person falling out of bed; under no circumstances should they be climbed or leaned upon. When lowering the rails take care not to drop them - they should be lowered carefully.**



## 7.5 OPERATION OF CASTORS

All castors on the bed can be braked using the foot pedal and must always be in the braked position during normal operation.



**The brakes must only be released to move the bed. Please also refer to the Safety Information.**



## 8 CARE, CLEANING & DISINFECTION

Clean and disinfect the bed before placing into service and before each re-use. To clean the care bed, wipe the bed by hand with a damp cloth. Use suitable cleaning and conditioning agents for wooden and synthetic furniture.

Household cleaners without ammonium or scouring agents are also allowed, but these should be dermatologically tested.

Solvents and scouring agents are not allowed, as these attack and damage the various surfaces of the care bed.



**Before cleaning and disinfection, the mains plug must be unplugged and hung up safely. Plugs for the handset and the motors which are inserted in the control unit MUST remain plugged in. This is necessary to ensure water does not get into the control system.**



**The brakes must only be released to move the bed. Please also refer to the Safety Information**

# MAINTENANCE

## 9. ELECTRIC EMERGENCY LOWERING VIA THE INTEGRATED 9V BATTERY

### 9.1 POSITION AND PRINCIPLE OF OPERATION

The power supply unit fitted (item 8, Overview) on the bed frame is equipped with a 9V block battery, which makes it possible to make an emergency lowering according to EN 60601-2-52 in the event of a power failure. Please note, however, this is only possible once per 9V battery, as the capacity of the 9V battery is limited.

After the emergency lowering has been used once, the 9V battery must be replaced with a new one (Type 6LR61 alkaline manganese battery). The 9V battery should however, be replaced every 2 years even if it has not been used.

### 9.2 BATTERY CHANGE

To replace, check or remove before lengthy storage of the 9V battery, open the battery compartment on the power supply unit attached to the backrest motor.



#### UNPLUG MAINS PLUG

- 1 Unplug from the low voltage control unit at the plug of the connection cable from the SMPS transformer box.
- 2 Pull out the battery carrier (the black plastic ring protruding from the control box) and remove the 9V battery. If required, replace it with a new (type 6LR61 alkaline manganese) battery.

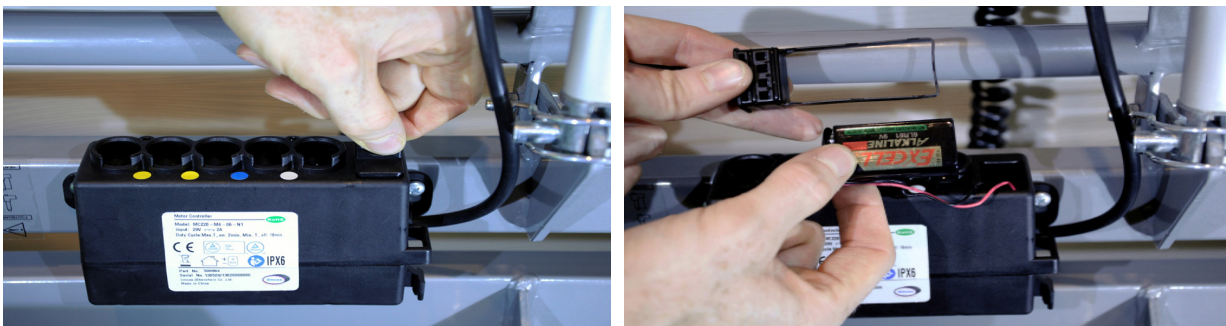

- 3 Reinstall the battery carrier. Be careful not to damage the wires or washer.

# TROUBLESHOOTING

Begin by information gathering:

- Model
- Serial number

Note: Serial number is located on the right-side head end of the bed, on the barcode at the left-hand side of the foot end and on the front of both actuators for the lift systems.

Then follow this series of troubleshooting steps:

1. Is the lock on the back of the handset in the unlocked position (open padlock)?
  - Yes. Action: Go to 2.
  - No. Action: Unlock the handset by turning the lock (see figures 1-3).



Fig 1: Woburn Handset



Fig 2: Ultra Low Bed Handset



Fig 3: Community/Ultimate Bed Handset. Lower lock controls the entire bed, this is the one that matters and is the same as the Woburn handset

2. Is there a light on the SMPS (the box located on the power cable, approximately one metre from the plug) and, if so, what colour is it?
  - Yes, the light is green. Action: Go to 4.
  - No, there is no light. Action: Go to 3.
3. Remove the screw from the connector just after the SMPS. Once the screw is removed the plastic cover will lift off. Separate the connector, turn the power supply off and wait 60 seconds. After 60 seconds turn the power to the SMPS on and check the light. Is the light on?
  - Yes, light is illuminated. Action: Replace control box or Printed Circuit Board (PCB).
  - No, there is no light. Action: Replace the SMPS (NOTE: The ultra low bed uses a different SMPS)
4. Try to operate the handset - can clicking be heard from the control box?
 

NB clicking from the handset is normal and not what you are looking for, please confirm sounds are from the control box attached to the underside of the sleeping platform.

  - Yes. Action: Possible broken DC power cable.
  - No. Action: Go to 5.
5. Press the backrest function – does it move very slowly?
  - Yes. Action: Possible broken DC power cable.
  - No. Action: Possible handset fault. If possible, test on another bed to confirm.



In the event of an actuator fault (one function on the bed not working):

1. Disconnect the connection on the SMPS as shown in section 3 above.
2. Plug the actuator that does not work into the female socket on the SMPS.
  - If the actuator operates the actuator is good, problem is the handset (~80% chance) or a loose connection in the control box. Go to 3.
  - If the actuator does not operate replace the actuator - obtain part code from the label on the headboard.
3. Try a different handset (if available).

Once you have completed the above contact Harvest Healthcare with the make/model of the bed, serial number and results of the above procedures.

# SERVICING

## 10 SERVICING

### 10.1 PRINCIPLES

Operators of care beds are obliged according to MPBetreibV (Operators of Medical Products Ordinance) §4 to guarantee the safe condition of the medical product over their entire service life.

The test according to the regulation EN 62353 contains the following minimum requirements:

- Visual check
- Measurement of leakage resistance
- Measurement of leakage current
- Functional test
- Overall evaluation

The service life of the care bed depends essentially upon the handling and servicing.

To guarantee safe operation, a visual and functional test including an electrical test must be carried out at least once a year. For this purpose, proceed according to the technical safety checklist as per regulation EN 62353 in section **10.2**



**If you have any doubts about the safety or functionality of the bed or even a part of the bed as a result of the work performed below, the bed should under no circumstances be put into service again. Contact the supplier or manufacturer in this case.**

# SERVICE RECORD

## 10.2 LIST OF TECHNICAL SAFETY CHECKS ACCORDING TO EN 62353

Care bed: **WOBURN Ultimate** Person in charge: .....

Serial No.: ..... Location: .....

	INSTRUCTION FOR TESTING	COMMENT	YES	NO
1	Is the general condition OK?			
2	Are the type plates for the bed and the motors legible?			
3	Is the Instruction Manual available to staff?			
4	Is the use for which it was intended and is it safe?			
5	No surface damage or corrosion?			
6	Mechanical components and welded joints without faults?			
7	Are all mechanical connecting elements securely fixed?			
8	Mattress base underside undamaged?			
9	Can all adjustment options for the bed be operated without hindrance on site?			
10	Is the mechanism for locking the leg rest in place in working order?			
11	Has the load test been carried out successfully according to the regulations?			
12	Are the patient's lifting pole with the grab handle and the lifting pole sleeve undamaged and without any signs of wear?			
13	Have castors including locking brake been tested for safe functioning?			
14	Mains cable, connecting cables and plugs without damage?			
15	Fixture available for safe transportation of mains plug?			
16	Strain relief of the mains cable and handset securely attached?			
17	Are all plug-in connections securely attached? (Washers without damage?)			

# SERVICE RECORD

	INSTRUCTION FOR TESTING	COMMENT	YES	NO
18	Are cables laid correctly and safely? (No damage)			
19	Motor housing and SMPS housing, mains plug housing without damage?			
20	Are the thrust pipes of the height adjustment motors undamaged?			
21	Functional test of the handset: can the buttons be operated properly?			
22	Functional test of handset locking device: On/Off working correctly?			
23	Testing of initial fault safety by means of integrated blocking box in handset?			
24	9V block battery OK / expiry date sufficient until next test?			
25	Is the safe working load adhered to?			
<b>Overall evaluation of the bed: Bed OK?</b>				

Comments: .....

.....

.....

.....

.....

.....

.....

Place/date: ..... Next inspection: .....

Inspected by: ..... Signature: .....



**The care bed must be serviced every 12 months in order to take advantage of the 5 year warranty. Please contact Harvest Healthcare if you require another copy of this service record.**

# SERVICING



## 10.3 CHECKING THE INITIAL FAULT SAFETY BY MEANS OF THE INTEGRATED CONTROL BOX IN THE HANDSET

To check the safety equipment, proceed as follows:



**The switching positions I and II are testing settings used only to check the safety during the annual inspection, or after repair work, or each time bed is put into service again.**



- Setting switch position 4 - padlock symbol open   
Move all bed adjustments to a slightly raised position.
- Setting switch position 3 - padlock symbol closed   
When operating the adjustment buttons, no motorised adjustments should be possible.
- Set switch on the back of the handset to testing position 1 (symbol I).  
When operating the adjustment buttons, no motorised adjustments should be possible.
- Set switch on the back of the handset to testing position 2 (symbol II).  
When operating the adjustment buttons, no motorised adjustments should be possible.

## 10.4 MEASUREMENT OF OVERALL ELECTRICAL SYSTEM



**The measurements described here must only be performed by a qualified electrician or by an electrotechnically trained person, (using suitable measuring and testing devices).**

The measurements shall include as a minimum the testing of the housing leakage current and the measurement of the isolation resistance.

The following measured values must be attained:

- Housing leakage current  $\leq 0.2\text{mA}$
- Isolation resistance  $\leq 7\text{M}\Omega$

During testing, the corresponding button on the handset must be kept constantly pressed.

The measurement is to be performed between:

- The control unit and the bed frame
- The control unit and the handset



# SERVICING

## 11 GUARANTEE

As stated in our Standard Terms and Conditions, we provide a manufacturer's warranty of 5 years from the date of purchase.

To take advantage of the 5 year warranty, the bed must be serviced (without exception) every 12 months by a Harvest Healthcare Ltd approved technician using only Harvest Healthcare Ltd original spare parts. A service record must be completed (an example can be found on **pages 30-31**).

## 12 SERVICE LIFE & DISPOSAL



The service life of our care beds in domestic use is assumed to be approximately 5 years. This depends upon the manner of use. The care bed is suitable for reuse if all measures of section 6.3 and 10 are taken. Frequent transportation, setting up and adjustment reduce the service life, as do improper treatment, irregular servicing and exceeding the safe working load or the admissible load cycle of the electric motors. The care bed must not be disposed of as normal household waste after the end of its service life. To ensure that it is disposed of in an environmentally compatible way please contact Harvest Healthcare Ltd.

# TECHNICAL SPECIFICATION

## 13 TECHNICAL SPECIFICATION

### 13.1 TECHNICAL DATA (MECHANICAL)

#### Woburn Ultimate 1200/1400

Safe working load (max. admissible load)	380 kg						
Individual loads of the safe working load	<table> <tr> <td>Max. weight of patient</td> <td>300 kg</td> </tr> <tr> <td>Mattress</td> <td>27/31 kg</td> </tr> <tr> <td>Accessories</td> <td>53 kg</td> </tr> </table>	Max. weight of patient	300 kg	Mattress	27/31 kg	Accessories	53 kg
Max. weight of patient	300 kg						
Mattress	27/31 kg						
Accessories	53 kg						
	Total						
	380 kg						
Safe load, patient's lifting pole	80 kg						
Max. weight of patient	300 kg						
Max. mattress height:	127- 260 mm						
Length	2195 mm (in the case of 2000mm wide mattress base)						
Width:	1340 mm (in the case of 1200mm wide mattress base) 1540 mm (in the case of 1400mm wide mattress base)						
Upper level of head section/foot section	850 mm / approx. 1275 mm						
Height adjustment of mattress base adjustable height from:	275 – 690 mm						
Back rest adjustable electrically up to	approx. 70°						
Thigh rest adjustment continually adjustable electrically up to	approx. 30°						
Foot rest in raised position	mechanically, -25°-0° in 4 stages						
Mattress base surface	Steel slatted base						
Aluminium side guards including plastic end caps	1973 x 70 x 28 mm						
Castors with individually lockable brake	Ø 100 mm with individual lockable brake						
Max. castor loading capacity	125 kg / pc. (static)						
Unloaded weight	170 kg						
Operating noise:	< 53 db(A) at a distance of 1m						

### 13.2 TECHNICAL DATA (ELECTRONIC)

Power supply unit (LIMOSS)	Control unit MC220 + SMPS MC125
Voltage rating	230/240V
Frequency rating	50/60 Hz
Type of current	AC ~
Nominal consumption during operation	8A x 29V = 232Watt ~ 250 Watt
Nominal consumption in idle state	0.30 Watt
Nominal operating time/idle time	10% on 2 Min. / off 18 Min (max. 5 switching cycles/min.)
Primary safety fuse	2.0 A
Battery for emergency lowering	9V block battery (alkaline manganese type 6LR61)
Mattress base motor units (back/leg)	3x MD100 (Fa. LIMOSS) 4x MD100 (Fa. LIMOSS)
Height adjustment motor unit	2x MD120 (Fa. LIMOSS)
Motor unit protection class	IPX4

# TECHNICAL SPECIFICATION

## 13.3 TECHNICAL DATA (ENVIRONMENT)

Temperature range during operation	+10°C to + 40°C
Temperature range for storage/transport	-10°C to + 60°C
Humidity of the air	30% to 75% RH.
Air pressure	Between 795 and 1060 hPa

## 13.4 CLASSIFICATION

Medical product	Class 1
Degree of protection to DIN EN 60601-1	Type B (protection against electric shock)
Housing degree of protection to EN60529	IPX 4 (not suitable for automated washing systems)
Max. duty rating	10%, ON 2 min / OFF 18 min
Max. switching cycles/min	5
Safety inspections	1 x per year

## 13.5 WEIGHTS OF INDIVIDUAL COMPONENTS

Ultimate Model	1200	1400
Mattress base / Head side	26	30 kg
Mattress base / Foot side	24	28 kg
Head end / Foot end (lifting steel frame incl. motor and full wooden cover)	45	52 kg/each
Aluminum side guards with end caps	16	16 kg
Patient lifting pole (optional)	4.2	4.2 kg (optional extra)
Grab Handle	3.7	3.7 kg (optional extra)
Transporting device (optional)	3.4	3.4

## 13.6 TYPE PLATE

Attached to the outside surface of the mattress base frame.

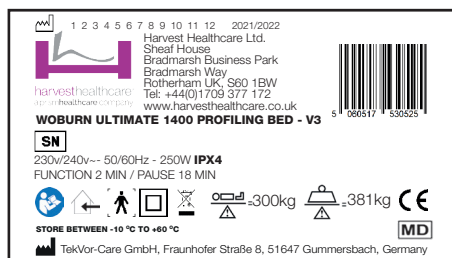
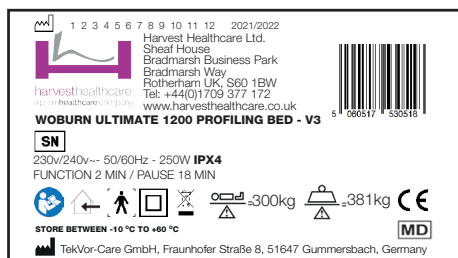

# EMC STATEMENT

## 13.7 INFORMATION ABOUT ELECTROMAGNETIC EMISSIONS

### Guidance and manufacturer's declaration - electromagnetic emissions

The care bed is intended for use in the electromagnetic environment specified below. The customer or user of the care bed should ensure that it is used in such an environment.

EMMITTED	COMPLIANCE	ELECTROMAGNETIC ENVIRONMENT GUIDELINES
RF emissions according to CISPR11	Group 1 -	The care bed uses RF energy only for its internal functioning. Therefore, its RF emissions are very low and it is unlikely that nearby electronic devices will be disturbed.
RF emissions according to CISPR11	Class B	The care bed is designed for use in all establishments including domestic establishments and those determined to be directly connected to a public supply network that supplies buildings used for residential purposes
Emissions of harmonics according to IEC61000-3-2	Class A	
Emissions of voltage fluctuations / Flicker according to IEC 61000-3-3	Complies	

# EMC STATEMENT

## Guidance and Manufacturer's Declarations - Electromagnetic Interference Immunity

The care bed is intended for use in the electromagnetic environment specified below. The customer or user of the care bed should ensure that it is used in such an environment.

INTERFERENCE	IEC 60601	COMPLIANCE LEVEL	ELECTROMAGNETIC ENVIRONMENT GUIDELINES
Electrostatic discharge (ESD) according to IEC 61000-4-2	± 6 kV contact discharge ± 8 kV air discharge	± 6 kV contact discharge ± 8 kV air discharge	Floors should be wood, concrete or ceramic tile floors. If the floor is covered with synthetic material, the relative humidity should be at least 30%.
Electrical fast transients / bursts according to IEC 61000-4-4	± 2 kV for power lines ± 1 kV for input & output lines	± 2 kV for power lines ± 1 kV for input & output lines	The quality of the supply voltage should be equivalent to that of a typical business or hospital environment.
Surges according to IEC 61000-4-5	± 1 kV Voltage phase-phase conductor ± 1 kV Voltage phase-ground conductor	± 1 kV Voltage phase-phase conductor ± 1 kV Voltage phase-ground conductor	The quality of the supply voltage should be equivalent to that of a typical business or hospital environment.
Voltage dips, short interruptions and supply voltage variations according to IEC 61000-4-11	< 5 % $U_T$ for ½ cycle (> 95% dip) 40 % $U_T$ for 5 cycles (60% dip) 70 % $U_T$ for 25 cycles (30% dip) < 5 % $U_T$ for 5s (> 95% dip)	< 5 % $U_T$ for ½ cycle, 10 ms (> 95% dip) 40 % $U_T$ for 5 cycles, 100 ms (60% dip) 70 % $U_T$ for 25 cycles, 500 ms (30% dip) < 5 % $U_T$ for 5s (> 95% dip)	The quality of the supply voltage should be equivalent to that of a typical business or hospital environment. If the user of care bed also requires continued operation during interruptions in energy supply demands, it is recommended to feed the care bed from an uninterruptible power supply or a battery.
Magnetic field of power frequency (50 / 60 Hz) according to IEC 61000-4-8	3 A/m	3 A/m 0.3 A/m	Magnetic fields of power supply frequency should comply with the typical values, as can be found in a business and hospital environment.

# EMC STATEMENT

## Guidance and Manufacturer's Declarations - Non-life-support devices Electromagnetic Interference Immunity.

The care bed is intended for use in the electromagnetic environment specified below. The customer or user of the care bed should ensure that it is used in such an environment.

INTERFERENCE	IEC 60601	COMPLIANCE LEVEL	ELECTROMAGNETIC ENVIRONMENT GUIDELINES
<p>Conducted RF interferences according to IEC 61000-4-6</p> <p>Emitted RF interferences according to IEC 61000-4-3</p>	<p>3 V eff 150 kHz - 80 MHz</p> <p>3 V/m 80 MHz - 2.5 GHz</p>	<p>3 V eff</p> <p>3 V/m</p>	<p>Portable and mobile radios, including cables, should not be used closer to the care bed than the recommended working clearance that is calculated by the equation for the appropriate frequency.</p> <p>Recommended working clearance</p> $d = \left[ \frac{3,5}{V_1} \right] \sqrt{P}$ $d = \left[ \frac{3,5}{E_1} \right] \sqrt{P} \quad \text{for 80 MHz - 800 MHz}$ $d = \left[ \frac{7}{E_1} \right] \sqrt{P} \quad \text{for 800 MHz - 2.5 GHz}$ <p>Where P is the power of transmitter in watts (W) according to specifications of the transmitter manufacturer and D is the recommended working clearance in meters (m)</p> <p>Field strengths from fixed RF transmitters should, at all frequencies, according to a site survey a - Note p. 5 be lower than the level of agreement be b - Note p. 5</p> <p> In the vicinity of equipment, bearing the following symbol, interference is possible.</p>
<p>Note 1: At 80 and 800 MHz, the higher frequency range must be taken.</p> <p>Note 2: These guidelines may not apply in all situations. The propagation of electromagnetic waves is affected by absorption and reflection from structures, objects and persons.</p>			

# EMC STATEMENT

- a. Field strengths from fixed transmitters, such as base stations of mobile telephones and land mobile radios, amateur radio, AM and FM radio and TV broadcast can not be predicted theoretically with accuracy. To assess the electromagnetic environment due to fixed RF transmitters, an electromagnetic site survey is recommended. If the field strength at the location of the care bed exceeds the specified compliance level above, then the care bed should be monitored with respect to its normal operation. If abnormal performance is observed, it may be necessary to take additional measures, such as reorienting or relocating the care bed.
- b. Over the frequency range 150 kHz to 80 MHz, field strengths should be less than 3 V/m.

## Recommended working clearances between portable and mobile RF communications equipment and the care bed

The care bed is intended for use in an electromagnetic environment in which radiated RF disturbances are controlled. The customer or user of the care bed can help to prevent electromagnetic interference by maintaining a minimum distance between portable and mobile RF.

OUTPUT POWER OF TRANSMITTER - W	WORKING CLEARANCE ACCORDING TO TRANSMISSION FREQUENCY - M		
	150 kHz to 80 MHz at 3 V/m $d = \left[\frac{3,5}{V_1}\right]\sqrt{P}$	80 MHz to 800 MHz at 3 V/m $d = \left[\frac{3,5}{E_1}\right]\sqrt{P}$	800 MHz to 2.5 GHz at 3 V/m $d = \left[\frac{7}{E_1}\right]\sqrt{P}$
0.01	0.12	0.12	0.23
0.1	0.38	0.38	0.73
1	1.2	1.2	2.3
10	3.8	3.8	7.3
100	12	12	23

For transmitters not rated in the list above, the working clearance can be determined using the equation, which belongs to the transmitter, where  $P$  is the nominal output of the transmitter in watts (W) according to specifications of the transmitter manufacturer.

NOTE 1: An additional factor of 10/3 is applied when calculating the recommended working clearance between transmitters in the 80 MHz to 2.5 GHz frequency range in order to reduce the probability that a mobile/portable communication device unintentionally brought into the patient area could lead to interference.

NOTE 2: These guidelines may not apply in all situations. Propagation of electromagnetic waves is affected by absorption and reflection from structures, objects and persons.



**All parts and data continually undergo further development and may therefore deviate from the details given.**

# LABELS

## 13.8 LABELS

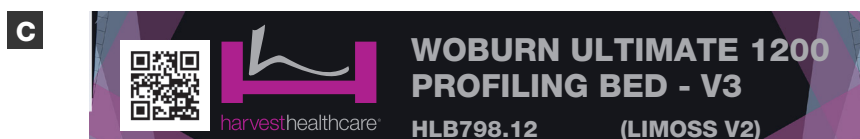
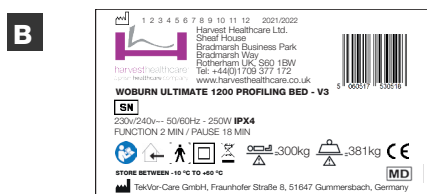
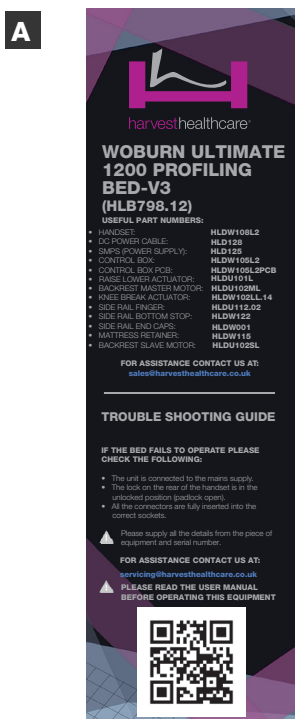

**A** Two trouble shooting labels are placed on the outer edge of the head/footboards. A basic parts number list is also included. In the event of a bed malfunction please follow the trouble shooting guide on the label.

**B** Type Plate

**C** Two bed identity labels are placed on the head/foot section square tube below the lower actuator mounting facing outward. The label shows the name and part number of the bed and the control system version.



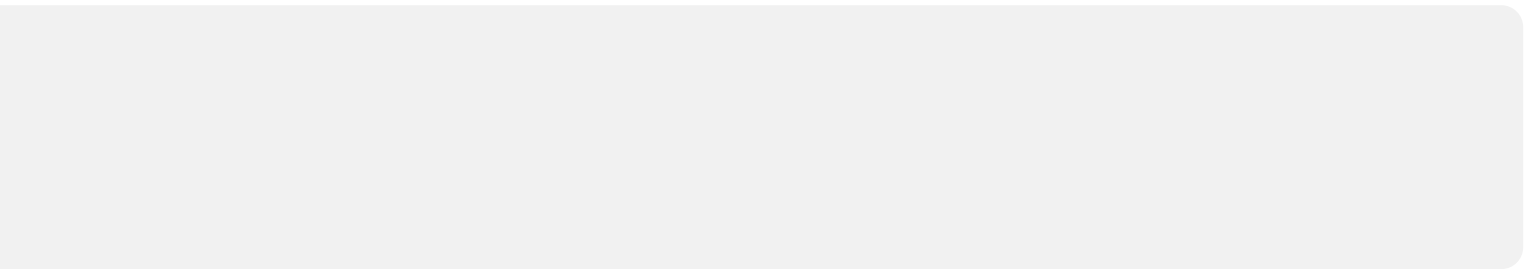

# DATE OF PURCHASE

Date of purchase:.....

Distributor stamp:.....

You can fix your receipt here:

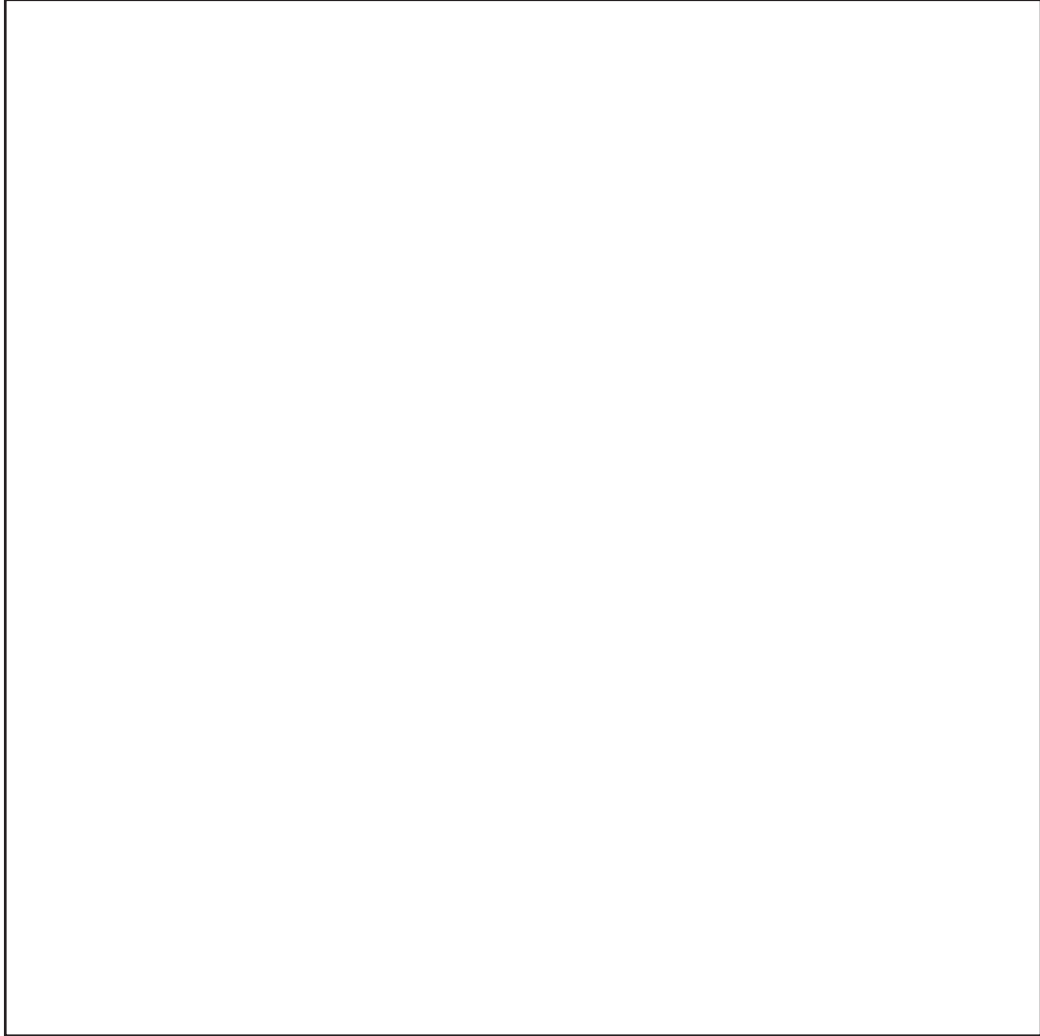

# NOTES

A series of horizontal dotted lines intended for writing notes.



Special Products and Service

**Contact Us**

Units 5 and 6 Lower Vicarage  
Road  
Southampton  
Hampshire  
SO19 7RJ  
T: 02380 420678  
E: [info@easycare systems.co.uk](mailto:info@easycare systems.co.uk)

[www.easycare systems.co.uk](http://www.easycare systems.co.uk)