

easyCare
systems

Shower Chairs,
Stretchers
and Trolleys



FREEWAY

www.easycare systems.co.uk

QUALITY. D

Backrests and handles

All models are available with either horizontal push handles or vertical handles for use in restricted areas or over WCs. The backrest is pliable and moulds to the user while providing excellent support.

FREECOTE

All Freeway chairs are treated with Freecote, our unique anti-bacterial and anti-microbial coating. The coating is durable and prolongs the life of the chair.

Frames

Available in three sizes:

- 'A' - 540mm (21") wide
- 'B' - 490mm (19") wide
- 'C' - 440mm (17") wide

High performance wheels

With stainless steel bearings and puncture proof tyres.

Brakes

Self-propelled models have large wheel brakes fitted as standard.

Castors

Highest quality large diameter plastic castors with stainless steel bearings.

Armrests

With soft but supportive tops. The armrests detach or swing away for easy access and transfer.

Seats

Fully padded, horseshoe or full ring seats with different sized apertures that are interchangeable.

Footrests

They flip up and are height adjustable. They can also be easily removed or swung conveniently away from the user's foot area.



DURABILITY. HYGIENE.

Bespoke, cost effective toileting and showering solutions

Manufactured in the UK from only the highest quality materials, the comprehensive range of Freeway assisted or self-propelled shower, toilet and commode chairs are designed to provide the most effective solution to a client's toileting and showering needs.

Freeway Shower Chairs are of **modular design**, and can be configured to a choice of interchangeable seats, backrests, armrests and footrests. A multitude of accessories are available to ensure the most bespoke solution.

All adult models within the range are specifically designed to fit over a standard toilet or commode, with three widths available; 'A' - 540mm (21"), 'B' - 490mm (19") and 'C' - 440mm (17"). Paediatric, Bariatric and models to fit over automatic toilets are also included in the range.

The interchangeable makeup of Freeway Shower Chairs makes the range one of the most cost effective on the market, as accessories and parts can be added to suit the changing needs of a client. Frames can be lowered/raised; rear wheels set back/forward and the frame depth extended/shortened.

Where there are special needs, Freeway can manufacture a bespoke shower chair subject to an individual assessment.

All standard models are weight tested to 200kg (30 stone)* and come with a standard 12 month warranty.

* excluding the Freeway T80 which is tested to 160kg (25 stone)



FREEWAY

Shower



Freeway T20 Moulded Shower Seat Chair

Available as a static model or with four castors. It has a moulded polypropylene seat and fixed arms.



Freeway T30 Free Standing Shower Chair

The Freeway T30 is a static shower chair with slip resistant rubber feet or floor fixing options available.



Freeway T40 Assistant Propelled Shower Chair

Versatility is the key with the T40 as it can be raised/lowered, extended forward, rear castors set back for amputee use, to name but a few of its applications. Features four total stop castors and footrests as standard.



The **Freeway T40 COM** is a version of the standard T40 which has been modified to work seamlessly with the Clos-o-Mat Samoa toilet.

The **Freeway T40 AUTO** is for use with automatic toilets including the Geberit 8000 range and Clos-o-Mat Palma Vita. Features pram handle backrest and seat with skirt as standard.



Chairs

All models available as shower, toilet or commode chairs.

(Excluding T20)



Freeway T50 Front Wheel Self Propelled Shower Chair

The Freeway T50 features 510mm (20") braked front wheels and includes footrests as standard. It is ideal for operating in tight spaces due to the positioning of the castors.

Freeway T60 Self Propelled Shower Chair

Benefits from a short overall length making it ideal for small shower cubicles. The chair's low braked wheel facilitates seamless side transfers as the top of the wheels are below the seat height of the chair. Anti-tip bars are featured as standard. Suitable for self-propelled or assistant propelled as the 510mm (20") rear wheel aids manoeuvring over a lip or small step.



Freeway T70 Self Propelled Shower Chair

Benefits from large braked rear wheels making this chair easy to self-propel.

The standard self-propelled model with 560mm (22") rear wheels has easily removed push rims and footrests fitted.

Freeway T70 COM: Modified to work seamlessly with the Clos-o-Mat Samoa toilet.

Freeway T70 AUTO: Designed specifically for use with automatic toilets including the Geberit 8000 range and Clos-o-Mat Palma Vita.

Freeway T70 Side Access: Equipped with left/right side opening and adapted, swing away armrests.



Reclining



Freeway T80 Reclining Shower Chair

The Freeway T80 is highly versatile and the reclined position has significant advantages for a wide range of conditions, increasing comfort and relieving pressure.

Such conditions include:

- Multiple sclerosis
- Spinal injuries
- Motor Neurone Disease
- Stroke
- Cerebral palsy
- Other neurological conditions

The chair reclines through an infinite number of positions up to 45 degrees. The tilt action is easy and light to operate.

The Freeway T80 is available as assistant propelled or self propelled and has a Safe Working Load of 160kg (25 stone).

An extensive range of accessories are available for this model such as a full or half height detachable headrest.

Freeway T80 COM

A variation of the T80 reclining shower chair, designed to work seamlessly with the Clos-o-Mat Samoa toilet.

Freeway T80 AUTO

A version of the standard T80 which has been modified for use with automatic toilets including the Geberit 8000 range and Clos-o-Mat Palma Vita.



Paediatric

The Freeway Paediatric Shower Chair range features a seat width of 360mm and a seat depth of 325mm

Freeway T80 Paediatric Reclining Shower Chair

The Freeway T80 Paediatric is a reclining shower or toilet/commode chair that has been purpose built for the needs of younger clients.

Freeway T90 Paediatric Shower Chair

The Freeway T90 Shower Chair/Commode features a seat height of 460mm. Footplates are flip up, removable and height/depth adjustable. The T90 is available as an assisted or self propelled model.



The **Freeway T90 WC** is a variation of the above, but for usage as a toilet commode - with a seat height of 560mm, allowing clearance over standard toilets and automatic bidets. NB: Self propelled model is wider due to the splayed frame

All models available as shower, toilet or commode chairs.

Bariatric



Freeway T100 Bariatric Shower Chair

The Freeway T100 carries up to 350kgs (55 stone) and is suitable for a variety of applications for bariatric clients. Seat dimensions are 790mm wide and 550mm deep.

The T100 benefits from increased diameter tubing, special heavy duty castors, and heavy duty footrests with heel supports which are height adjustable, removable and swing away. The T100 is also available in smaller width frames than the standard.

Adaptations and A

Freeway Shower Chairs can have special adaptations, accessories and alterations to suit specific needs. Some of the options shown here may be fitted to an existing chair, others will be available only on a new build. Many will need adapting to your special size/situation requirements, subject to an individual assessment.

Armrest Options



Raised/lowered armrests



Flip up arms (only on new chair orders)



Gull wing arms (only on new chair orders)



Extended forward armrests



Gutter armrests (with or without strap supports)



Padded style armrests

Backrest Options



5° reclined backrest



Extended backrest



Detachable headrest



Clip on padding for backrests and armrests



Curved padded head support

Footrest Options



Raised footrests (60, 90 or 120mm higher)



Heavy duty footrests



Integral heel supports with Velcro toe/foot straps



Clip on padded foot tray



Individual clip on foot tray



Wrap around vinyl footrest covers



Dartex footplate sleeve



ABS foot tray



Padded ABS foot tray



Sandals foot holder (New footrest orders only)



Adjustable leg support and footrest



Adjustable angle footrest



Adjustable stump support



Double padded stump support



Padded double leg support (optional dimensions)

Accessories

Straps, Harnesses and Positional Aids



Waist band Velcro fastening



Waist band buckle fastening



Full harness



Ankle strap



Vinyl calf support



Armrest Padding



Adjustable lateral Supports



Trunk supports, padded



Trunk supports unpadded



Knee block (only on new chairs)



Black curved thoracic support (only with extended backrests)



Curved thoracic supports (can be purchased as a retro fit kit for all T80 length backrests)



Thoracic wedge

Hygiene



Commode pan



Cup shaped splashguard



Lower commode pan tray



Pommel (photo shows adapted for use on horseshoe seat)

Seat Options

A padded seat is a major contributor to the comfort and support offered by any Freeway Shower Chair.

The huge choice of standard seats means that there is a seat for most situations yet we frequently supply custom seats for special situations.

The following are examples of this type of seat.

- Padding: Increased or extra comfort padding
- Reduced padding on seats
- Wedged padding
- Dartex upholstery (breathable four way stretch fabric allows more significant moulding of seat to user and may help with pressure relief)
- Different sized/shaped apertures
- Extended seat depths (over 75mm involves frame alteration)



Dartex Covered Seat

Other Options



Counter balance weights for double amputee



Extended brake levers



Capstans on wheels



T30 floor fixing kit

Build your own FREE

STEP 1

MODEL

- T30
- T40
- T40 COM
- T40 AUTO
- T50
- T60
- T70
- T70 COM
- T70 AUTO
- T70 Side Acc.
- T80 Assistant Pr.
- T80 Self Prop.
- T80 COM
- T80 AUTO

STEP 2

SEAT

A. Select your seat width

- 'A' 540mm (21")
 'B' 490mm (19")
 'C' 440mm (17")

B. Select your seat type

- 
 
 
- Horseshoe Fully padded Full ring

C. Select aperture size

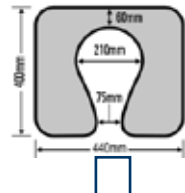
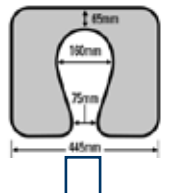
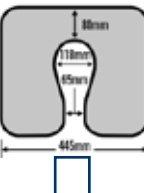
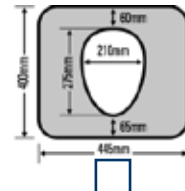
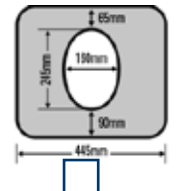
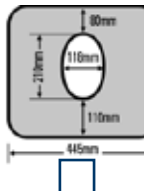
- | Large | Medium | Small |
|--|--|--|
|  <p>40mm, 210mm, 75mm, 445mm</p> <input type="checkbox"/> |  <p>45mm, 190mm, 75mm, 445mm</p> <input type="checkbox"/> |  <p>40mm, 118mm, 65mm, 445mm</p> <input type="checkbox"/> |
|  <p>40mm, 210mm, 75mm, 445mm</p> <input type="checkbox"/> |  <p>45mm, 190mm, 90mm, 445mm</p> <input type="checkbox"/> |  <p>40mm, 110mm, 110mm, 445mm</p> <input type="checkbox"/> |

D. Select seat extension if required

- Extra 50mm Extra 75mm

E. Select covering

- Dartex Vinyl

F. Select seat comfort

- Standard Extra comfort

STEP 3

BACKREST

Select your backrest

Choose between horizontal push handles or vertical push handles which can be useful where space is restricted or against a WC cistern.



Horizontal push handles



Vertical push handles



Pram style backrest (AUTO Chairs only)

Freeway Shower Chair

STEP 4

ARMREST

Select your armrests



Standard

Gives 370mm of clear width on a standard 'C' (440mm) frame



Half wide

Extra 50mm width



Wide

Extra 100mm width

* Measurements taken between armrests and across narrowest point.

STEP 5

FOOTREST

Select your footrests



Standard footrests

Adjust from the floor to 195mm



Raised footrests

60/90/120mm from standard.



Heavy duty footrests

STEP 6

TRANSPORT

Many Freeway Shower Chairs are available as a transportable option so that the frame can be easily dismantled without the need for tools, for ease of transport or storage.

For example:



T40 Assembled



T40 Disassembled (frame only)

Please speak to your representative for a full list of shower chairs with transportable option.

Transportable option

Yes No

STEP 7

ACCESSORIES

Select your accessories

Please quote the product name of the accessories that you require:











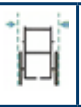

Your Freeway Shower Chair is complete!







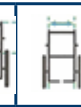



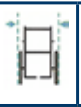

Pass your completed form to your local representative or call your local service centre.







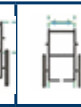



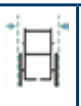

Shower Chair Tech







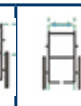





Below are the technical specifications of the most popular Freeway Shower Chair models. Please consult our website, www.prismmedical.co.uk for the full range of dimensions.







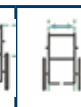





- 1 = Overall maximum height.
- 2 = Overall maximum width.
- 3 = Length including footrests (if fitted) at lowest position.
- 4 = Length including footrests (if fitted) at highest position.
- 5 = Width of standard seat.
- 6 = Height to top of seat.
- 7 = Height clearance.
- 8 = Seat depth (standard seat).
- 9 = Top of armrest to top of seat.
- 10 = Width clearance.
- 11 = Top of backrest to seat.
- 12 = Distance between armrests at rear.
- 13 = Distance between armrests at front.













T30														
		1	2	3	4	5	6	7	8	9	10	11	12	13
T30A (SC only)		920	640	570	570	540	460	345	400	180	485	450	470	530
T30B (SC only)		920	590	570	570	490	460	345	400	180	435	450	420	480
T30C (SC only)		890	540	570	570	440	460	345	400	180	385	450	370	430













T40														
		1	2	3	4	5	6	7	8	9	10	11	12	13
T40A		980	640	1050	960	540	560	445	400	180	485	450	470	530
T40B		980	590	1050	960	490	560	445	400	180	435	450	420	480
T40C		980	540	1050	960	440	560	445	400	180	385	450	370	430
T40A AUTO		1000	590	1050	960	540	560	480	400	180	485	450	460	530
T40B AUTO		1000	540	1050	960	490	560	480	400	180	435	450	410	480
T40C AUTO		1000	540	1050	960	440	560	480	400	180	385	450	410	430
T40A COM		980	690	1050	960	540	560	470	400	180	485	450	470	530
T40B COM		980	590	1050	960	490	560	470	400	180	435	450	420	480
T40C COM		980	540	1050	960	440	560	470	400	180	385	450	370	430















T50														
		1	2	3	4	5	6	7	8	9	10	11	12	13
T50A		980	730	940	900	540	560	445	400	180	485	450	470	530
T50B		980	680	940	900	490	560	445	400	180	435	450	420	480
T50C		980	630	940	900	440	560	445	400	180	385	450	370	430

T60														
		1	2	3	4	5	6	7	8	9	10	11	12	13
T60A		980	710	1050	970	540	550	435	400	180	485	450	470	530
T60B		980	660	1050	970	490	550	435	400	180	435	450	420	480
T60C		980	610	1050	970	440	550	435	400	180	385	450	370	430

T70													
	1	2	3	4	5	6	7	8	9	10	11	12	13
T70A	980	750	1150	1100	540	560	445	400	180	485	450	470	530
T70B	980	700	1150	1100	490	560	445	400	180	435	450	420	480
T70C	980	650	1150	1100	440	560	445	400	180	385	450	370	430
T70A AUTO	1000	790	1140	1060	540	560	480	400	180	485	450	460	530
T70B AUTO	1000	740	1140	1060	490	560	480	400	180	435	450	410	480
T70C AUTO	1000	690	1140	1060	440	560	480	400	180	385	450	410	430
T70A COM	980	775	1110	1020	540	560	470	400	180	485	450	470	530
T70B COM	980	725	1110	1020	490	560	470	400	180	435	450	420	480
T70C COM	980	675	1110	1020	440	560	470	400	180	385	450	370	430

T90 Paediatric													
	1	2	3	4	5	6	7	8	9	10	11	12	13
T90 Assistant Prop.	920	620	730	N/A	360	460	N/A	330	130	N/A	440	300	340
T90 Self Propelled	920	620	880	N/A	360	460	N/A	330	130	N/A	440	300	340
T90WC Assistant Pr.	980	470	680	N/A	360	560	470	330	130	430	440	320	320
T90WC Self Prop.	980	680	880	N/A	360	560	470	330	130	430	440	320	320

T100 Bariatric													
	1	2	3	4	5	6	7	8	9	10	11	12	13
T100	990	900	1220	1170	790	570	450	550	170	730	430	720	760
T100FR	990	900	1220	1170	790	570	450	550	170	730	430	720	760

T80 Recliner															
	1	2	3	4A	4B	4C	5	6	7	8	9	10	11	12	13
T80A	1125	1440	640	1040	1300	1500	540	570	445	400	190	480	535	470	530
T80B	1125	1440	590	1040	1300	1500	490	570	445	400	190	430	535	420	480
T80C	1125	1440	540	1040	1300	1500	440	570	445	400	190	380	535	370	430
T80A COM	1125	1440	730	1040	1300	1500	540	570	470	400	190	480	535	460	530
T80B COM	1125	1440	680	1040	1300	1500	490	570	470	400	190	430	535	410	480
T80C COM	1125	1440	630	1040	1300	1500	440	570	470	400	190	380	535	410	430
T80A AUTO	1125	1440	730	1040	1300	1500	540	570	470	400	190	480	535	470	530
T80B AUTO	1125	1440	680	1040	1300	1500	490	570	470	400	190	430	535	420	480
T80C AUTO	1125	1440	630	1040	1300	1500	440	570	470	400	190	430	535	370	430
T80 Paediatric	1050	1345	590	760	1050	1170	360	570	470	325	145	430	530	360	360

T80 Specification Key

- 1 = Height.
- 2 = Height with detachable headrest.
- 3 = Width.
- 4A = Length in upright position.

- 4B = Length with max. recline including footrests at highest position.
- 4C = Length max. recline and detachable headrest fitted.
- 5 = Seat width.
- 6 = Height to top of seat.
- 7 = Height clearance.
- 8 = Seat depth (standard seat).

- 9 = Top of armrest to top of seat.
- 10 = Width clearance.
- 11 = Top of backrest to top of seat (without detachable headrest fitted - with headrest add 300mm).
- 12 = Distance between armrests at rear.
- 13 = Distance between armrests at front.

DURABLE. MANOEUVREABLE.

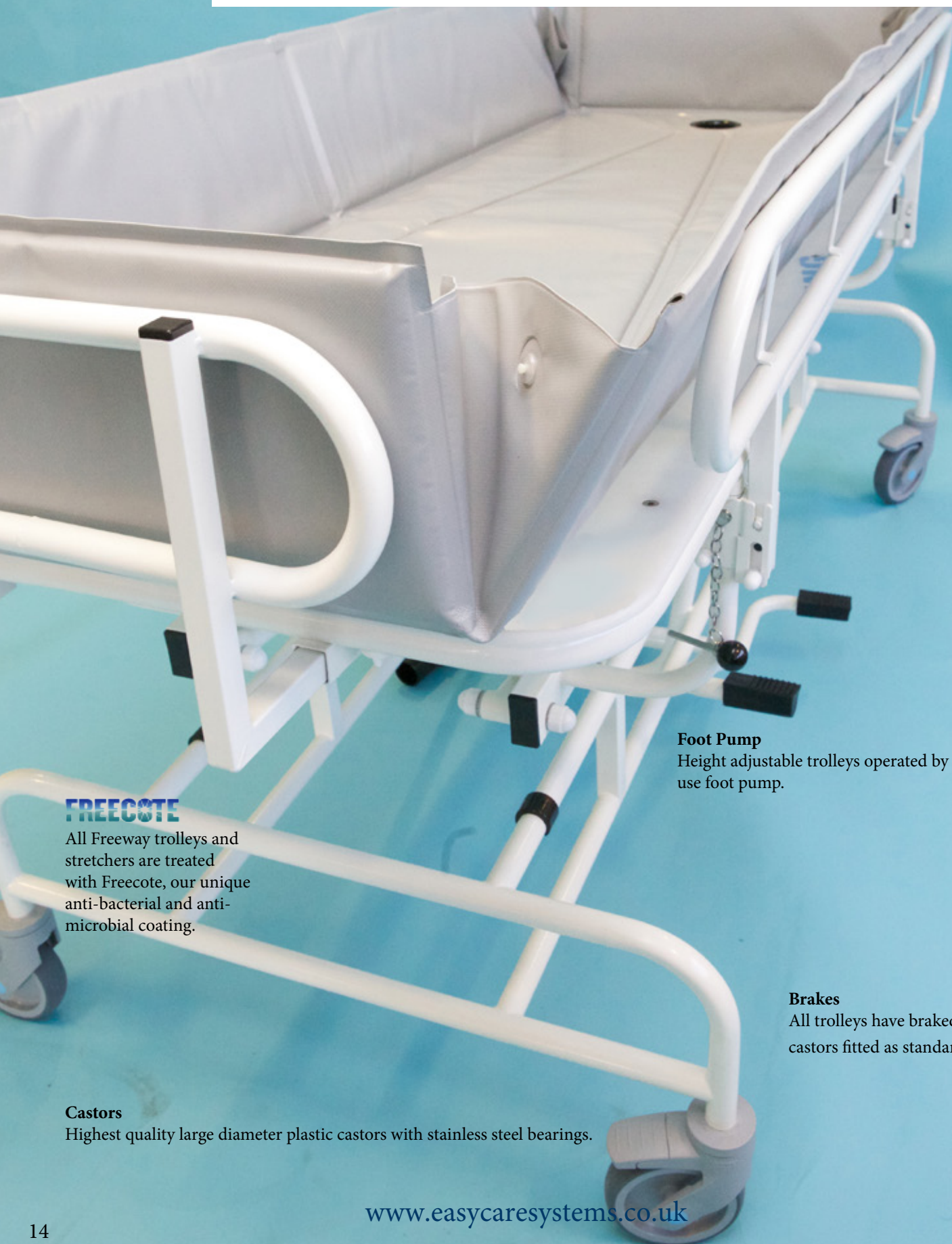

FREECOTE

All Freeway trolleys and stretchers are treated with Freecote, our unique anti-bacterial and anti-microbial coating.

Castors

Highest quality large diameter plastic castors with stainless steel bearings.

Foot Pump

Height adjustable trolleys operated by easy to use foot pump.

Brakes

All trolleys have braked castors fitted as standard.

ADAPTABLE. PRACTICAL.

Shower trolleys and stretchers for all care environments

Manufactured in the UK to the same high standards as the Freeway Shower Chair Range, the comprehensive range of Freeway Shower Stretchers and Trolleys allow carers to shower, change and transfer clients in a safe and dignified manner.

Multiple fixed height and adjustable height options are available throughout the range to ensure carers are working in the safest possible position in order to reduce the risk of injury to themselves and the client.

The Freeway Shower Trolley and Stretcher range has been long established as a market leader due to their durability and versatility, making them suitable for use in a wide range of care environments including hospitals, care homes and individual residences.

All standard models are weight tested to 200kg (30 stone) and come with a standard 12 month warranty.



Shower Stretcher



Freeway Wall Mounted Shower Stretcher

The Freeway Wall Mounted Shower Stretcher is our economy shower stretcher with vinyl top and drainage holes. Photo shows optional padded cot side.

Available in six sizes from 1400mm to 1900mm and can be adjusted on installation up to a working height of 900mm.

Freeway Wall Mounted Shower Stretcher with Padded Roll Edge

This Freeway Wall Mounted Shower Stretcher benefits from a padded roll edge for safety and comfort which often means the cotside is not necessary.

Available in six sizes from 1400mm to 1900mm and can be adjusted on installation up to a working height of 900mm. Option to add some sag to the vinyl or fit a skirt.



Freeway Wall Mounted Shower Stretcher with Adjustable Backrest

This Freeway Wall Mounted Shower Stretcher is available with adjustable backrest and can be left or right handed. Available in six sizes.



Wall Mounted Padded Shower Stretcher & Changing Table

This Freeway model serves two purposes in one as it can be used as both a shower stretcher and a changing table. It benefits from a comfortable 50mm vinyl upholstered covering and is available in three sizes: 1500mm, 1700mm and 1900mm.

rs & Trolleys



Freeway Fixed Height Shower Trolley

The Freeway Fixed Height Flat Bed Shower Trolley is our economy model which benefits from top quality sealed bearing castors and the option of cot sides on long sides or all round. Available in six sizes; from 1400mm to 1900mm.

The **Freeway Fixed Height Padded Shower Trolley** has exactly the same specification as above but with padded top included. Available in three sizes; 1500, 1700 and 1900mm.

The **Freeway Fixed Height Shower Trolley with Liner** has cotsides all round and liner included (as shown in photo above). Available in three sizes; 1500mm, 1700mm and 1900mm.

The **Freeway Fixed Height Shower Trolley with Adjustable Backrest** is available with adjustable backrest and can be left or right handed.

Freeway Adjustable Height Shower Trolley

The Freeway Adjustable Height Shower Trolley benefits from optional cot sides and is height adjustable by hydraulic foot pump. Six sizes available from 1400mm to 1900mm.

Freeway Adjustable Height Shower Trolley with Adjustable Backrest

This Freeway Adjustable Height Shower Trolley is a variation of the above with the added inclusion of an adjustable backrest. Six sizes available.





Freeway Adjustable Height Padded Changing Trolley

This Freeway Adjustable Height Shower Trolley benefits from a comfortable one piece padded top.

Photo features optional cot sides all round. Three sizes available; 1500mm, 1700mm and 1900mm.

Freeway Adjustable Height Trolley with ABS Top & Liner

This Freeway Adjustable Height Shower Trolley benefits from an ABS top and padded liner with an optional pillow.

It is height adjustable by hydraulic pump to a working height of between 600mm to 925mm. Three sizes available; 1500mm, 1700mm, and 1900mm.



Shower Stretcher Technical

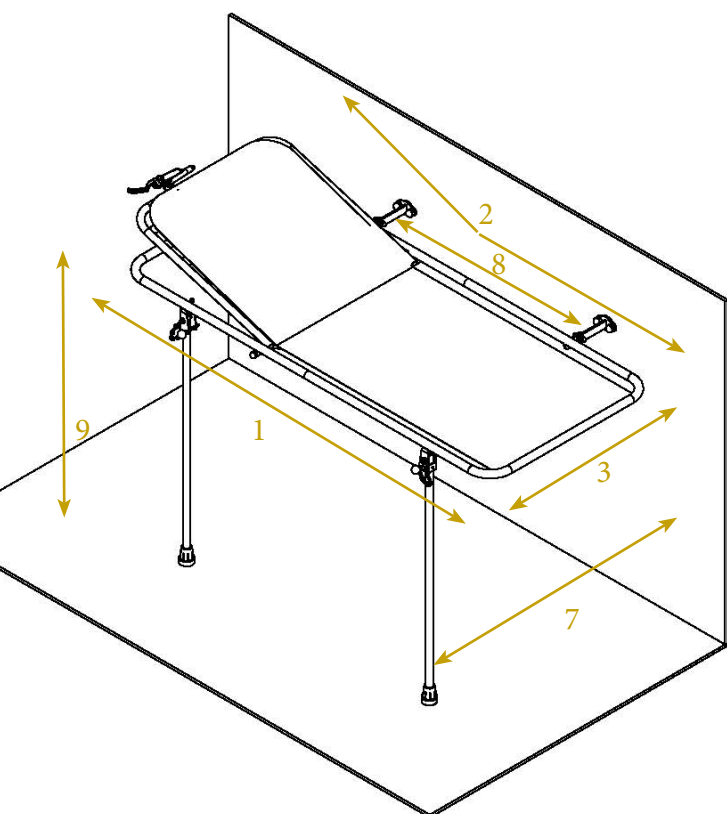

Dimensions based on a standard 1900mm length Shower Stretcher

- 1 = length = 1900mm
- 2 = length with adjustable headrest = 1975mm
- 3 = width = 670mm
- 4 = width when fitted with standard brackets = 810mm
- 5 = width when fitted with short brackets = 760 mm
- 6 = width when fitted with cot side = 835/785mm
- 7 = distance from wall to inside of legs = 795mm/745mm
- 8 = distance between bracket hinges = 1100mm
- 9 = height = 900mm
- 10 = distance from wall when folded up = 120mm

NB: Padded rolled edge increases width/length by 50mm

Shower Trolley Technical

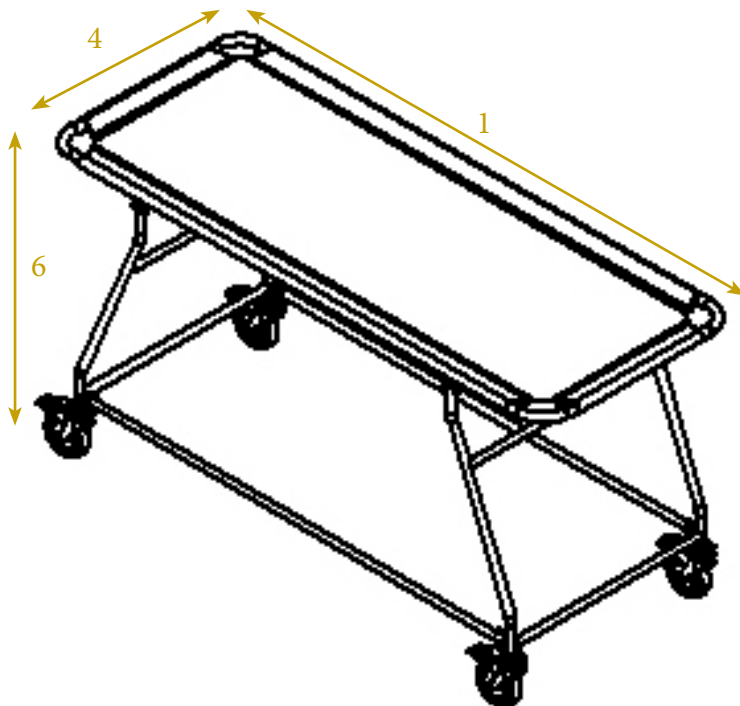

Fixed Height Shower Trolley (based on a standard 1900mm)

- 1 = length = 1900mm
- 2 = length with adjustable headrest = 1975mm
- 3 = length with cot ends fitted both ends = 1950mm
- 4 = width = 670mm
- 5 = width with cot sides both sides = 720mm
- 6 = height = 900mm
- 7 = height with cot sides fitted = 1100mm

Adjustable Height Shower Trolley (based on a standard 1900mm)

- 1 = length = 1900mm
- 2 = length with adjustable headrest = 1975mm
- 3 = length with cot ends fitted both ends = 1950mm
- 4 = width = 670mm
- 5 = width with cot sides both sides = 720mm
- 6 = overall max width = 810mm
- 7 = min working height = 625mm
- 8 = max working height = 925mm
- 9 = max height with cot sides fitted = 1125mm
- 10 = length of trolley base = 1500mm

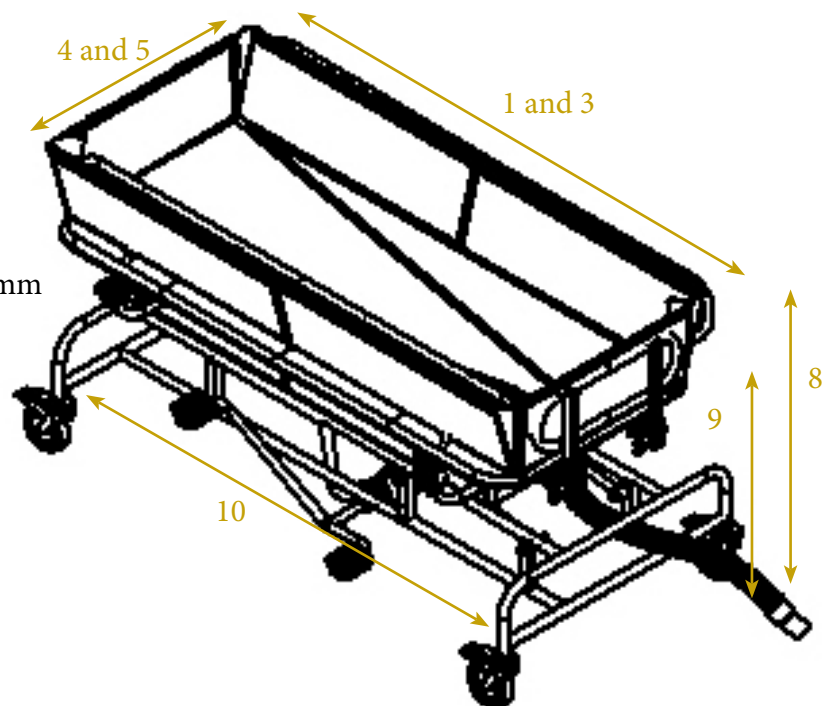

Wedged pillow dimensions - width = 550mm, length = 330mm, height = 110mm
 Waste hose dimensions (for trolley with liner) - length = 1 metres, diameter = 75mm



Contact Us

Units 5 and 6 Lower Vicarage Road Southampton
Hampshire
SO19 7RJ
T: 02380 420678
E: info@easycare systems.co.uk



www.easycare systems.co.uk