

## M205 Mobile Hoist



## User Manual

## CONTENTS

1.0	Safety Instructions and Warnings.....	4
1.1	Introduction.....	4
	.....	
	.....	
1.4	Symbols Used .....	5
1.5	Contraindications / Limitations.....	6
1.6	Intended Use .....	6
1.7	Warning Notes .....	7
1.8	Operating Environment.....	7
2.0	Components / Key Parts .....	8
3.0	Assembly instructions .....	9
3.1	Unpacking.....	9
3.2	Unboxing Hoist.....	9
3.3	Hoist Assembly.....	10
3.4	Electrical Connections .....	11
4.0	Final Inspection .....	11
5.0	Operating instructions .....	12
5.1	Manoeuvring the Hoist .....	12
5.2	Raising and Lowering .....	12
5.3	Open / Close Mobile Hoist Legs .....	12
5.4	Emergency Stop Button .....	13
5.5	Emergency Lowering .....	13
5.5.1	Manual Emergency Lowering .....	13
5.5.2	Electrical Emergency Lowering.....	13
5.6	Handset Operations .....	13
5.6.1	Battery Status - Handset.....	14
5.6.2	Service Indication.....	14
5.7	Battery.....	15
5.7.1	Charging the battery pack.....	15
5.7.2	Battery Status – Control Box.....	15
5.8	Control Box Display .....	16
5.8.1	Service Information read-out: .....	16
5.9	Slings.....	17

- 5.9.1 Sling Attachment/Detachment ..... 17
- 5.9.2 Compatible Slings..... 17
- 6.0 Detachable Parts ..... 24
  - 6.1 Attaching/detaching QRS (Quick Release System) Carry Bar ..... 24
  - 6.2 Attaching/detaching the Battery ..... 25
- 7.0 Technical Specification..... 26
  - 7.1 Freeway M205 Mobile Hoist Dimensions ..... 26
  - 7.2 Specifications..... 27
  - 7.3 Electrical Specifications ..... 27
  - 7.4 Standards Applied ..... 27
- 8.0 Environmental - Storage and Operating Conditions ..... 28
  - 8.1 Normal Operating Conditions ..... 28
  - 8.2 Shipping and storage conditions ..... 28
- 9.0 Disposal ..... 28
- 10.0 Fault Finding..... 29
- 11.0 General Inspection, Maintenance and Cleaning..... 30
  - 11.1 Service..... 30
  - 11.2 Inspection ..... 31
  - 11.3 Cleaning ..... 31
    - 11.3.1 General cleaning ..... 32
    - 11.3.2 Disinfecting (if necessary) ..... 32
- 12.0 Warranty ..... 34
- 13.0 Service Record History ..... 35

## 1.0 SAFETY INSTRUCTIONS AND WARNINGS

### 1.1 Introduction



Please read and understand this manual in its entirety before using your Freeway M205 Mobile Hoist.

The information in this manual is important for the safety of anyone near the Freeway M205 Hoist and must be read and understood to help prevent injuries. It is also crucial to the proper operation and maintenance of the Mobile Hoist.

The Hoist is designed to be used in conjunction with slings and accessories. Please refer to any user guides supplied with these components while reviewing this manual.

Should any questions arise from reviewing this manual, contact your local authorised representative.

Failure to comply with warnings in this manual may result in; injury to the operator and/or client and/or damage to the Mobile Hoist or related components.

If, during the use of this device or as a result of its use a serious incident has occurred, please report it to the manufacturer and to your national authority.

Store this manual with the documents included with the Mobile Hoist and sling(s). Contents of this manual are subject to change without prior written notice Ensure you are aware of the sling manufacturer's fitting instructions.



Do not attempt to use this equipment without first understanding the contents of this manual.



Unauthorised modifications on any Prism Medical UK product may affect its safety. The manufacturer will not be held responsible for any accident, incident or deficiencies of performance that occur as a result of any unauthorised modification to its products.



Do not use a clip fit sling on a lifting arm designed specifically for loop fitting slings.



Figure 1

## 1.4 Symbols Used

The Table below includes all Symbols from BS EN ISO 15223-1:2016 that can be found in this Manual and on the Product and what they represent. Refer back to this Table when you are unsure of what a symbol represents.













	Consult instructions before use		Caution – see instructions for use
	Manufacturer	<b>SWL</b>	Safe Working Load represents the maximum load rated for safe operation
	Packaging indicator – This way up		Date of manufacture
	Serial number		Packaging indicator – Keep dry
	Please observe local laws on recycling		For internal use only
	Temperature range	<b>IP<sub>N<sub>1</sub>N<sub>2</sub></sub></b>	Degree of protection provided by enclosure. N <sub>1</sub> : Ingress of particles N <sub>2</sub> : Ingress of water
	Humidity range	<b>MD</b>	Medical Device
	Catalogue number	<b>EC REP</b>	European Authorised Representative

Table 1

## 1.5 Contraindications / Limitations

There are no known “contraindications” associated with the usage of the Freeway M205, provided they are used as per manufacturer’s recommendations and guidelines. However, it is recommended that a client specific assessment is completed by a trained and knowledgeable health care professional to determine the method of transfer.

Prism Medical UK does not recommend a required number of care givers for the use of our products. This information and recommendation can only be provided after a thorough personalized, case specific assessment, as there are many factors that can influence these decisions.

## 1.6 Intended Use



For internal use only.

The Mobile Hoist is a lifting aid used by trained personnel. The Mobile Hoist makes it possible to transfer/lift mobility impaired clients with minimal strain or risk to the caregiver, while providing complete safety, dignity and comfort to the client.

The Mobile Hoist is one of two components that makes this possible. The other component, the sling, is a specially designed fabric accessory that attaches to the Hoist by means of a carry bar and straps, and holds the client during the lift/transfer.

Please refer to the user guides supplied with the sling and reference them while reviewing this manual.

The functions of raising and lowering the boom, and opening and closing of the legs on the Hoist, are accomplished by pressing buttons on the hand control. The hand control is attached to the Mobile Hoist.



The device is used under instruction, and the operation of the aid is undertaken by a trained carer.

A risk assessment must be performed before using any other manufactured slings or Mobile Hoist, to ensure safe use can be established.

- The Freeway M205 Mobile Hoist is intended to be installed on a flat and levelled surface prior to use.
- The Hoist must be installed only by persons authorized by Prism Medical UK or who have the rights to install and commission the Hoist safe for use.
- Under no circumstance should the Freeway M205 Mobile Hoist or entire system be put in control of a person who has not been properly trained in the use and care of this equipment. Failure to adhere to this warning may result in serious injury to the operator and/or the individual being transferred.
- In facilities where more than one operator will be responsible for using the Mobile Hoist and sling(s) it is imperative that all such members be trained to use the Freeway M205 Mobile Hoist. A training program should be established by the facility to acquaint new operators with this equipment.
- The Freeway M205, and associated slings are not toys. Do not use it for unsafe practices. Do not allow children to play with the Hoist or any of its components.
- Your guarantee is void if persons unauthorized by Prism Medical UK perform work on the Mobile Hoist.
- To maintain optimum function, the Freeway M205 Mobile Hoist should be inspected and maintained on a regular basis. See section ‘General Inspection, Maintenance and Cleaning’ within this user manual.
- Any accessories used with this Mobile Hoist including belt(s), should be checked to ensure that they are in good working order. Check for signs of wear to each component prior to use. Report any unusual wear, or damage immediately to your local authorised dealer.

- The Freeway M205 Mobile Hoist and Slings(s) are intended only for transferring of a person. Prism Medical UK will not be responsible for any damage caused by the misuse, neglect or purposeful destruction of the Unit, and/or its associated components.
- The Mobile Hoist and its associated parts are certified to a maximum load of 205kg. Do not exceed the maximum rated load of any of the components.
- Ensure that a clear space is maintained around the Mobile Hoist. Before performing a transfer, check for and move all obstacles out of the way.
- Your Product is for aiding and transferring a patient. Do not use it, or allow it to be used, for any other purpose.
- Protecting the people present, visually monitor the sling(s) loops connection points during transfer stages, so the belt remains firmly attached to the clipped carry bar.
- In areas where children are prone to be present be vigilant when carrying out a transfer.
- To reduce the risk of unintended use, when the Hoist is not in use, remove the sling(s) from the product to prevent entrapment or strangulation should the device be tampered with.
- Between Hoist, Spreader Bar and Body-Support Unit, the lowest maximum load shall always be used.



You may need to seek specialist advice on how to assist some people with specific moving and handling needs. Sources of advice include, but is not limited to, professional bodies and organisations, occupational therapist, physiotherapists, manual handling advisers and ergonomist with experience in health and social care.

### 1.7 Warning Notes



Your Freeway M205 Mobile Hoist has been manufactured and tested to exceed BS EN 10535:2006. This does not mean that it can be used without care. ALL OPERATORS should have read the operating instructions and appreciate this warning section.

1. ALL Mobile Hoists are less stable on sloping surfaces. A 5-degree slope is the maximum permitted and then only with great care.
2. ALL Mobile Hoists are dangerous to the person being transferred when used recklessly or pushed at speed.

### 1.8 Operating Environment

The M205 Mobile Hoist is intended for use within the professional healthcare facility environment as well as the home health care environment. The Hoist is not suitable for any other environment or special environments.

The Mobile Hoist is not intended to be used in environments where there are rapid changes in the environmental temperature and humidity during intended use.

## 2.0 COMPONENTS / KEY PARTS

Please see below to familiarise yourself with the components of the Freeway M205 Mobile Hoist. The image below show the contents of the Hoist. If you have not received all the components contact Prism Medical UK dealer immediately – contact details are provided on the last page of this manual.

Item	Description	Item	Description
1	Boom	6	Handle
2	Mast	7	Front Casters
3	Control Box & Battery	8	Leg Actuator
4	Manual Emergency lower	9	Base
5	Carry Bar /Carry Bar cover	10	Rear Casters
11	Serial Number/ Product Information	12	Lift Actuator

Table 2



Figure 2



## 3.0 ASSEMBLY INSTRUCTIONS

### 3.1 Unpacking



Some of the parts are heavy and will need to be lifted with care. Items weighing over 20kg will require a two person lift. Please refer to (7.0) technical specifications for components weights.



The Hoist will arrive to you in a robust box, please be careful when removing the components from the box. Please read the user guide in full before operating.

This user manual should be kept safe for future reference.

The Hoist has been specifically designed to be installed in both the professional and home health care environments.

No matter the environment, health and safety factors should be considered to ensure the safety and essential performance of the Hoist and to avoid unnecessary damage or injuries to people within the area of the Mobile Hoist.

The environment in which the Mobile Hoist is situated in, whilst carrying out a transfer, is required to be on a flat surface with no steep inclines.

### 3.2 Unboxing Hoist



When using a sharp knife, be careful not to damage the product.

This section will summarise the layout of the Hoist Packaging and what is included in the Box. It is recommended a knife is used for smoother unpacking of the Hoist. The Hoist is packed into a single box (750x450x400) weighing approximately 45kg.

Using a knife to open the box around the perimeter, the box should open, and the internal packaging must be removed to access the Hoist. It will include all the following components. It is recommended that the components are removed in the numerical order below.

1. Mast
2. Base
3. Fixings
4. Hand Control
5. Charging Lead
6. User Manual

### 3.3 Hoist Assembly

- A. Carefully open the box and remove all loose parts and excess packaging from the box.



2 person lift recommended for the following points.

- B. Carefully holding onto the handle and boom, lift the Hoist components out of the box. Place carefully onto the floor.
- C. With one person lifting up from the front castors and one person lifting up from the rear castors, raise the base from the box and place the Hoist base on a flat surface and ensure the rear braked castors are locked.
- D. Remove the Star Handle and bolt from the top of the base (as shown in Fig. 3).
- E. Ensure all cables are clear from entrapment while fitting the base and mast together. (As shown in Fig. 4).



Figure 3

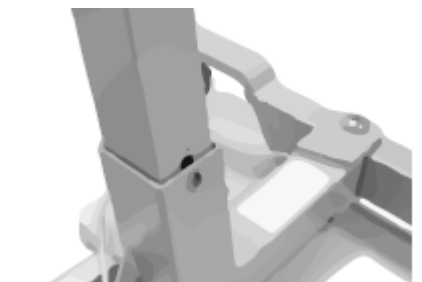

Figure 4



Please ensure both hands are on the handles when lifting the mast into position, possible risk of finger trap.

- F. When the mast is fully engaged with the base, fit and fully tighten the Star Handle and Bolt. (As shown in Fig. 5 and 6).



Figure 5



Ensure the mast is fully seated into the base and the Star Handle is in position and tight before using the Hoist.



Figure 6

NOTE: To disassemble the Hoist into the two main sections (Mast/boom and Base) simply follow the previous steps in reverse.

### 3.4 Electrical Connections



Connect all the cables to the control box as shown in the pictures opposite.

- A. Connect the lift actuator cable connector to the second port (marked No. 1) from the left side of the control box (as shown in Fig. 7).
- B. Connect the leg actuator cable connector to the third port (marked No. 2 in Fig. 8)
- C. Connect the handset connector to the large port on the left side of the control box. A locator pin on the plug ensures correct orientation of the connector (as shown in Fig. 9).
- D. Connect the mains cable/power cord to the control box (as shown in Fig. 10).



Figure 7



Figure 8



Figure 9



Figure 10



Ensure that all cables are located and secure before operating the Mobile Hoist

## 4.0 FINAL INSPECTION

Before first operation of the Hoist:

- Confirm all cables are located and secure.
- Ensure the red emergency stop button on the control box is deactivated. (Rotate clockwise to release if required- Refer to section 5.4 for guidance).
- Press the up button on the handset and confirm the actuator raises the boom.
- Press the down button on the handset and confirm the actuator lowers the boom.
- Press the button on the handset to operate the opening of the legs and confirm the actuator moves the legs outwards.
- Press the button on the handset to operate the closing of the legs and confirm the actuator moves the legs inwards.
- Press the red emergency stop button on the control box and check that actuators do not operate until the button is reset. (See section 5.4 for guidance)
- Check the mechanical emergency lowering function works properly. (See section 5.5 for guidance)
- Check the rear castors brakes work properly.
- Check the battery pack is fully charged.

Your Hoist is now ready to use.

## 5.0 OPERATING INSTRUCTIONS



The Mobile Hoist may be heavy for users and will need to be lifted with care, please operate the device with the use of the castors wherever possible to prevent any injury.

Appropriate training in lifting and handling procedures should be undergone by any person operating the Mobile Hoist, for their own and the client's safety and comfort. These instructions are designed to cover the method of using the Mobile Hoist.

### 5.1 Manoeuvring the Hoist

- A. To move the Hoist forward, hold onto the handle bar and push forward.
- B. Do not stand on the leg actuator, or use the leg actuator to push the Hoist (Fig. 11 and 12).
- C. When turning the Hoist, use both hands on the handle. Alternatively, it is possible to rotate the Hoist by applying the brake to a single rear castor and rotating the Hoist about the braked castor. This movement should be performed with a smooth, slow action to avoid swinging the patient unnecessarily.
- D. The Freeway M205 Mobile Hoist has two rear castors with brakes.
- E. The rear castors can be braked for rotation (by applying a single brake), lateral movement, and parking. To apply the brake, press the brake pedal down with your foot (as shown in Fig.13). To release the brake, press the raised pedal towards the wheel (as shown in Fig. 14).
- F. During lifting, the rear castors should remain locked to ensure that the Hoist will not move.



The castors should be locked if there is a risk of the Hoist driving into the patient. For example, when lifting the patient from the floor.



Figure 11



Figure 12



Figure 13



Figure 14

### 5.2 Raising and Lowering

The up and down movement of the boom on the Freeway M205 Mobile Hoist is achieved by an electric actuator which is controlled by hand control. The hand control has two buttons with directional arrows up and down. The actuator stops automatically at the limit of travel in both directions.

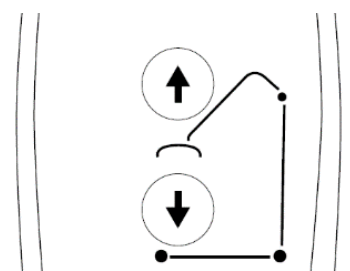

Figure 15

### 5.3 Open / Close Mobile Hoist Legs

The legs of Freeway M205 Mobile Hoist are opened/closed using the appropriate buttons on the hand control, see figure 15 for guidance. The legs motion will be stopped whenever the hand control button is released. The legs can be opened to enable access around arm chairs or wheel chairs. When relocating the Mobile Hoist, manoeuvring through narrow doorways and/or passages, the Mobile Hoist legs should be in the closed position.

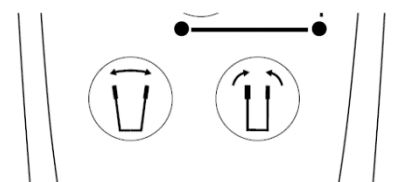

Figure 16

## 5.4 Emergency Stop Button

The Freeway M205 Mobile Hoist is fitted with an Emergency Stop button.

Push the Emergency Stop button (as shown in Fig. 17) to cut all power to the Mobile Hoist.

To resume power, release the emergency stop button by turning in a clockwise direction (indicated by arrows on the Emergency Stop button) as shown in Fig. 18.



Figure 17



Figure 18

## 5.5 Emergency Lowering

### 5.5.1 Manual Emergency Lowering

In the case of power failure, it is possible to mechanically lower a patient suspended by the Freeway M205 Mobile Hoist.

Turn the manual lowering handle in clockwise direction (as shown in Fig. 19) to lower the boom until the boom reaches a safe position.



Figure 19



The manual emergency lowering system should be used only if the lowering procedures described in the previous section of the manual do not work. Should you have any concerns or questions contact your local authorised Mackworth Representative.



Do not use the Hoist after the manual lowering mechanism has been used. The lift must be reset by a qualified technician after use. Contact your local authorised Mackworth Service Provider.

### 5.5.2 Electrical Emergency Lowering

The Mobile Hoist Boom can be raised and lowered by pushing the emergency lifting and lowering buttons on the control box with a suitable object, such as a pen nib or pencil (as shown in Fig. 20).

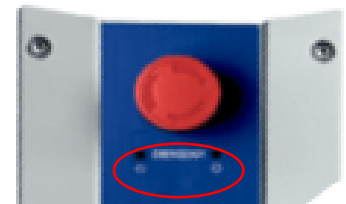

Figure 20

## 5.6 Handset Operations

The Hand Controls has 4 functions: Up and Down, this will raise and lower the Mobile Hoist, and Legs Open and Legs Close, these functions will open and close the legs.

Press down on each symbol to operate the desired function. It is not possible to use two functions at the same time. Once the Mobile Hoist has reached the extent of its travel in a given direction, the actuator will automatically stop, allowing you to then choose the opposite direction.

The handset is attached to the control box via a flexible, coiled cable that is secured in place with a friction-fit plug. The coiled cable is designed to give the greatest number of options for carer positioning without having a trailing cable around the patient. The handset also incorporates a hook which gives the carer flexibility whilst moving/positioning the patient. Clear and easy to understand labelling of the buttons enable ease of use for the care giver.

The handset also displays battery level and service requirement by the use of LED lights.



Figure 21

### 5.6.1 Battery Status - Handset



Battery State	Indication	Comment
1		The battery is OK - no need for charging (100-50%) the third LED is green
2		The battery needs to be charged (50-25%) the second LED is yellow
3		The battery needs to be charged (less than 25%) The buzzer sounds when a button is pressed The first LED is yellow
4		The battery needs to be charged. Some of the functionality of the lift is lost and it is only possible to drive the lifting arm down. By continuous use the diode blinks and starts to give an audio signal

Table 3

### 5.6.2 Service Indication

The service indicator (Yellow LED) will blink when it is time for service. The standard setting is every 12 months/ 8000 cycles, whichever comes first.

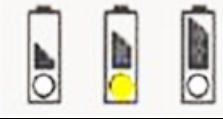

Indication	Comment
	When it is time for service, the service indicator will remain illuminated 2 minutes after use. Afterwards the control box will power down to save the battery.
	When the service indicator lights up the system will still be functional.

Table 4

## 5.7 Battery



The battery pack should never be stored for long periods of time without a regular charge.

The battery pack is protected in an encased unit located on top of the control box, on the rear of the product. The control box, below the battery, will inform the user when the battery is flat and requires charging, by an illuminated LED. An LED illuminate when the battery needs recharging. Complete the lift and place the battery on charge.

### 5.7.1 Charging the battery pack

The battery pack can be recharged via mains lead (terminated with a figure of eight plug)

- A. Fit the mains lead figure of eight plug into charger link cable (see Fig. 22).
- B. Plug the 2-pin mains plug into a suitable mains outlet and switch the mains supply on.
- C. Charging is automatic and will normally take eight to twelve hours to fully charge (from completely discharged state). You cannot overcharge the battery pack if left for longer periods of time.
- D. To return the Hoist to use, switch off the mains supply. Remove the plug from the socket and clip onto the Mast.
- E. The Hoist is now ready for use.



Figure 22

### 5.7.2 Battery Status - Control Box

The Table below provides information on the four battery states seen on the Control Box LCD. Refer to this table when unsure of what the symbols represent.

Battery State	Symbol	Comment
1		The battery is ok, no need for charging (100 - 50 %)
2		Battery needs charging (50 -25%)
3		Battery needs charging. (Less than 25%) Buzzer sound is provided when a button is pressed in this battery state.
4		The battery needs charging. At this stage some of the functionality of the lift is lost. At this battery stage, it is not possible to drive the lifting arm up or down. Furthermore, an audio signal will sound when a control button is activated (17V or lower). The symbol will switch between the two pictures for 10 seconds. The battery symbol is shown when the box is active until power down (2 minutes after use).

Table 5  
Table 5



### 5.8 Control Box Display

The Table below provides information on all Symbols seen on the Control Box display and what they represent. Refer to this table when unsure of a Symbol displayed on the Control Box.







Control Box Feature	Symbol	Comment
Charging of battery		When the mains cable is plugged in and a control button is activated the symbol to the left is shown on the display until power down 2 minutes later. The purpose if the symbol is to inform the user that it is not possible to use the lift when it is plugged into the mains.
Short Circuit		If there is a short circuit, the control box will show the short circuit symbol with a recommendation to check the connections. This symbol will be shown until the short circuit has been repaired.
Service		The control box will show the service symbol when it is time for service. The standard settings is after 12 months/8000 cycles. After each power down, first time that the symbol (100 milli-seconds) so that the user gets a reminder about checking the display. The 'SERVICE' Text will blink 3 times, then a static service symbol will be shown (10 seconds in total). Even though it is time for service the system will still be functional and work as normal.
Overload channel 1 only:		When Overload occurs (according to the pre-defined current cut-off limit) the overload symbol will be shown on the display. The 'MAX. Text will blink 3 times and the overload symbol will be shown for 10 seconds in total.

Table 6

#### 5.8.1 Service Information read-out:

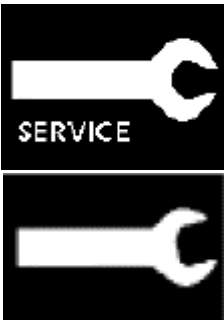
Basic service information can be read out on the display. To display the service information on the display press the lifting arm up button (Only for ½ second press). The information (below) will be shown for ½ minute or until other buttons are activated.

If “No Days” are chosen for service interval then the display will show Days since last service.

	12034	.....➔	Total cycles done on channel 1
A·S	1257000	.....➔	Total work done on channel 1
	7	.....➔	Total number of overloads (channel 1)
	90/360	.....➔	Days since last service/Days between services



## 5.9 Slings

The Freeway M205 is designed to be used in combination with a Sling to perform its intended use. The sections below include the correct and safe manor of attaching/detaching the Slings as well as a list of approved slings for use.

### 5.9.1 Sling Attachment/Detachment

Sling loops should be attached as follows:

1. Put the required sling loop onto your finger and thumb and then using the same finger or thumb, pull back the spring locking mechanism on the correct hook on the correct side of the carry bar (Figure 23).
2. Slide the sling loop from your finger and thumb over the edge of the hook (Figure 24).
3. After positioning the loop below the locking mechanism (Figure 25) release the spring locking mechanism to secure the sling loop (Figure 26).

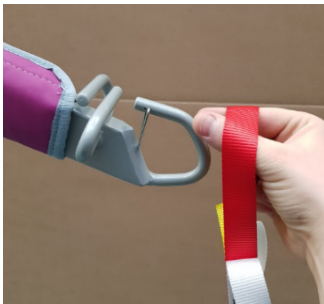

Figure 23



Figure 24



Figure 25



Figure 26

To remove the sling, simply reverse the process – pull back on the spring locking mechanism, lift the loop out of the hook and release the locking mechanism.



Figure 27



Figure 28

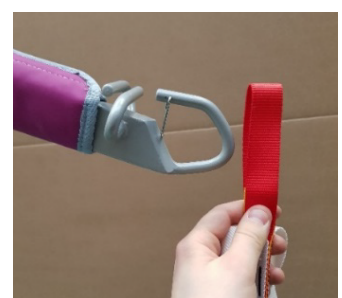

Figure 29

**The same process of attaching and detaching the Sling is relevant for the QRS (Quick Release System) Carry Bar.**

### 5.9.2 Compatible Slings

Below is a list of slings that are recommended and have been approved by Prism Medical UK for use in combination with the product.

We recommend the use of the Mackworth Healthcare or Care-Ability manufactured sling range (type 'BF' applied part) to be utilised with the Freeway M205 Mobile Hoist. It is at the user's discretion to use alternative supplied product. In utilising another manufacturer's sling, checks must first be made to ensure the sling is safe to use and meets the requirements of BS EN ISO 10535 before its use.

The slings with a safe working load of 205kg that can be used with the Freeway M205 Mobile Hoist are shown below in Table's 7 and 8, complete with product codes. For all components, the lowest maximum safe working load must always be adhered to.

Size	Mackworth Sling Range - Product Material and Code				
	Polyester Solid	Polyester Mesh	Parasilk	Quilted	Supersoft Spacer
<b>Mackworth Oak</b>					
Small	1201OK7500	1201OK8500	1201OK3500	1201OK5500	1201OK4500
Medium	1201OK7400	1201OK8400	1201OK3400	1201OK5400	1201OK4400
Large	1201OK7300	1201OK8300	1201OK3300	1201OK5300	1201OK4300
XL	1201OK7200	1201OK8200	1201OK3200	1201OK5200	1201OK4200
XXL	1201OK7100	1201OK8100	1201OK3100	1201OK5100	1201OK4100
XXXL	1201OK7000	1201OK8000	1201OK3000	1201OK5000	1201OK4000
<b>Mackworth Oak with head support</b>					
Small	1201OK7520	1201OK8520	1201OK3520	1201OK5520	1201OK4520
Medium	1201OK7420	1201OK8420	1201OK3420	1201OK5420	1201OK4420
Large	1201OK7320	1201OK8320	1201OK3320	1201OK5320	1201OK4320
XL	1201OK7220	1201OK8220	1201OK3220	1201OK5220	1201OK4220
XXL	1201OK7120	1201OK8120	1201OK3120	1201OK5120	1201OK4120
XXXL	1201OK7020	1201OK8020	1201OK3020	1201OK5020	1201OK4020
<b>Mackworth Yew</b>					
Small	1201YW7500	1201YW8500	1201YW3500	n/a	1201YW4500
Medium	1201YW7400	1201YW8400	1201YW3400	n/a	1201YW4400
Large	1201YW7300	1201YW8300	1201YW3300	n/a	1201YW4300
XL	1201YW7200	1201YW8200	1201YW3200	n/a	1201YW4200
XXL	1201YW7100	1201YW8100	1201YW3100	n/a	1201YW4100
XXXL	1201YW7000	1201YW8000	1201YW3000	n/a	1201YW4000
<b>Mackworth Yew with head support</b>					
Small	1201YW7520	1201YW8520	1201YW3520	n/a	1201YW4520
Medium	1201YW7420	1201YW8420	1201YW3420	n/a	1201YW4420
Large	1201YW7320	1201YW8320	1201YW3320	n/a	1201YW4320
XL	1201YW7220	1201YW8220	1201YW3220	n/a	1201YW4220
XXL	1201YW7120	1201YW8120	1201YW3120	n/a	1201YW4120
XXXL	1201YW7020	1201YW8020	1201YW3020	n/a	1201YW4020
<b>Mackworth Hazel</b>					
Small	1201HZ7500	1201HZ8500	1201HZ3500	1201HZ5500	1201HZ4500
Medium	1201HZ7400	1201HZ8500	1201HZ3400	1201HZ5400	1201HZ4400
Large	1201HZ7300	1201HZ8300	1201HZ3300	1201HZ5300	1201HZ4300
XL	1201HZ7200	1201HZ8200	1201HZ3200	1201HZ5200	1201HZ4200
XXL	1201HZ7100	1201HZ8100	1201HZ3100	1201HZ5100	1201HZ4100
XXXL	1201HZ7000	1201HZ8000	1201HZ3000	1201HZ5000	1201HZ4000
<b>Mackworth Hazel with head support</b>					
Small	1201HZ7520	1201HZ8520	1201HZ3520	1201HZ5520	1201HZ4520
Medium	1201HZ7420	1201HZ8520	1201HZ3420	1201HZ5420	1201HZ4420
Large	1201HZ7320	1201HZ8320	1201HZ3320	1201HZ5320	1201HZ4320
XL	1201HZ7220	1201HZ8220	1201HZ3220	1201HZ5220	1201HZ4220
XXL	1201HZ7120	1201HZ8120	1201HZ3120	1201HZ5120	1201HZ4120
XXXL	1201HZ7020	1201HZ8020	1201HZ3020	1201HZ5020	1201HZ4020
<b>Mackworth Willow</b>					
Small	1201WL7500	This sling is made up of a single quilted material backed with solid polyester material.			
Medium	1201WL7400				
Large	1201WL7300				

XL	1201WL7200				
XXL	1201WL7100				
XXXL	1201WL7000				
<b>Mackworth Willow with head support</b>					
Small	1201WL7520	This sling is made up of a single quilted material backed with solid polyester material.			
Medium	1201WL7420				
Large	1201WL7320				
XL	1201WL7220				
XXL	1201WL7120				
XXXL	1201WL7020				
<b>Mackworth Beech</b>					
Small	1201BC7500	1201BC8500	1201BC3500	1201BC5500	1201BC4500
Medium	1201BC7400	1201BC8400	1201BC3400	1201BC5400	1201BC4400
Large	1201BC7300	1201BC8300	1201BC3300	1201BC5300	1201BC4300
XL	1201BC7200	1201BC8200	1201BC3200	1201BC5200	1201BC4200
XXL	1201BC7100	1201BC8100	1201BC3100	1201BC5100	1201BC4100
XXXL	1201BC7000	1201BC8000	1201BC3000	1201BC5000	1201BC4000
<b>Mackworth Beech with head support</b>					
Small	1201BC7520	1201BC8520	1201BC3520	1201BC5520	1201BC4520
Medium	1201BC7420	1201BC8420	1201BC3420	1201BC5420	1201BC4420
Large	1201BC7320	1201BC8320	1201BC3320	1201BC5320	1201BC4320
XL	1201BC7220	1201BC8220	1201BC3220	1201BC5220	1201BC4220
XXL	1201BC7120	1201BC8120	1201BC3120	1201BC5120	1201BC4120
XXXL	1201BC7020	1201BC8020	1201BC3020	1201BC5020	1201BC4020
<b>Mackworth Pine</b>					
Small	1201PN7500	1201PN8500	1201PN3500	1201PN5500	1201PN4500
Medium	1201PN7400	1201PN8400	1201PN3400	1201PN5400	1201PN4400
Large	1201PN7300	1201PN8300	1201PN3300	1201PN5300	1201PN4300
XL	1201PN7200	1201PN8200	1201PN3200	1201PN5200	1201PN4200
XXL	1201PN7100	1201PN8100	1201PN3100	1201PN5100	1201PN4100
XXXL	1201PN7000	1201PN8000	1201PN3000	1201PN5000	1201PN4000
<b>Mackworth Pine with head support</b>					
Small	1201PN7520	1201PN8520	1201PN3520	1201PN5520	1201PN4520
Medium	1201PN7420	1201PN8420	1201PN3420	1201PN5420	1201PN4420
Large	1201PN7320	1201PN8320	1201PN3320	1201PN5320	1201PN4320
XL	1201PN7220	1201PN8220	1201PN3220	1201PN5220	1201PN4220
XXL	1201PN7120	1201PN8120	1201PN3120	1201PN5120	1201PN4120
XXXL	1201PN7020	1201PN8020	1201PN3020	1201PN5020	1201PN4020

Table 7

Size	Care-Ability Sling Range - Product Material and Code			
	Polyester	Mesh	Spacer	Parachute
<b>CA300 Universal</b>				
P1	CA300PP1	CA300MP1	CA300SP1	CA300PAP1
P2	CA300PP2	CA300MP2	CA300SP2	CA300PAP2
P3	CA300PP3	CA300MP3	CA300SP3	CA300PAP3
P4	CA300PP4	CA300MP4	CA300SP4	CA300PAP4
P5	CA300PP5	CA300MP5	CA300SP5	CA300PAP5

<b>X Small</b>	CA300PXS	CA300MXS	CA300SXS	CA300PXS
<b>Small</b>	CA300PS	CA300MS	CA300SS	CA300PAS
<b>Small/Medium</b>	CA300PSM	CA300MSM	CA300SSM	CA300PASM
<b>Medium</b>	CA300PM	CA300MM	CA300SM	CA300PAM
<b>Medium/Large</b>	CA300PML	CA300MML	CA300SML	CA300PAML
<b>Large</b>	CA300PL	CA300ML	CA300SL	CA300PAL
<b>X Large</b>	CA300PXL	CA300MXL	CA300SXL	CA300PAXL
<b>CA400 Universal Deluxe</b>				
<b>P1</b>	CA400PP1	CA400MP1	CA400SP1	CA400PAP1
<b>P2</b>	CA400PP2	CA400MP2	CA400SP2	CA400PAP2
<b>P3</b>	CA400PP3	CA400MP3	CA400SP3	CA400PAP3
<b>P4</b>	CA400PP4	CA400MP4	CA400SP4	CA400PAP4
<b>P5</b>	CA400PP5	CA400MP5	CA400SP5	CA400PAP5
<b>X Small</b>	CA400PXS	CA400MXS	CA400SXS	CA400PAXS
<b>Small</b>	CA400PS	CA400MS	CA400SS	CA400PAS
<b>Small/Medium</b>	CA400PSM	CA400MSM	CA400SSM	CA400PASM
<b>Medium</b>	CA400PM	CA400MM	CA400SM	CA400PAM
<b>Medium/Large</b>	CA400PML	CA400MML	CA400SML	CA400PAML
<b>Large</b>	CA400PL	CA400ML	CA400SL	CA400PAL
<b>X Large</b>	CA400PXL	CA400MXL	CA400SXL	CA400PAXL
<b>CA500 Toilet Access</b>				
<b>P1</b>	CA500PP1	CA500MP1	CA500SP1	CA500PAP1
<b>P2</b>	CA500PP2	CA500MP2	CA500SP2	CA500PAP2
<b>P3</b>	CA500PP3	CA500MP3	CA500SP3	CA500PAP3
<b>P4</b>	CA500PP4	CA500MP4	CA500SP4	CA500PAP4
<b>P5</b>	CA500PP5	CA500MP5	CA500SP5	CA500PAP5
<b>X Small</b>	CA500PXS	CA500MXS	CA500SXS	CA500PAXS
<b>Small</b>	CA500PS	CA500MS	CA500SS	CA500PAS
<b>Small/Medium</b>	CA500PSM	CA500MSM	CA500SSM	CA500PASM
<b>Medium</b>	CA500PM	CA500MM	CA500SM	CA500PAM
<b>Medium/Large</b>	CA500PML	CA500MML	CA500SML	CA500PAML
<b>Large</b>	CA500PL	CA500ML	CA500SL	CA500PAL
<b>X Large</b>	CA500PXL	CA500MXL	CA500SXL	CA500PAXL
<b>CA501 Toilet Access with crossover straps</b>				
<b>P1</b>	CA501PP1	CA501MP1	CA501SP1	CA501PAP1
<b>P2</b>	CA501PP2	CA501MP2	CA501SP2	CA501PAP2
<b>P3</b>	CA501PP3	CA501MP3	CA501SP3	CA501PAP3
<b>P4</b>	CA501PP4	CA501MP4	CA501SP4	CA501PAP4
<b>P5</b>	CA501PP5	CA501MP5	CA501SP5	CA501PAP5
<b>X Small</b>	CA501PXS	CA501MXS	CA501SXS	CA501PAXS
<b>Small</b>	CA501PS	CA501MS	CA501SS	CA501PAS
<b>Small/Medium</b>	CA501PSM	CA501MSM	CA501SSM	CA501PASM
<b>Medium</b>	CA501PM	CA501MM	CA501SM	CA501PAM

<b>Medium/Large</b>	CA501PML	CA501MML	CA501SML	CA501PAML
<b>Large</b>	CA501PL	CA501ML	CA501SL	CA501PAL
<b>X Large</b>	CA501PXL	CA501MXL	CA501SXL	CA501PAXL
<b>CA502 Toilet Access with head support</b>				
<b>P1</b>	CA502PP1	CA502MP1	CA502SP1	CA502PAP1
<b>P2</b>	CA502PP2	CA502MP2	CA502SP2	CA502PAP2
<b>P3</b>	CA502PP3	CA502MP3	CA502SP3	CA502PAP3
<b>P4</b>	CA502PP4	CA502MP4	CA502SP4	CA502PAP4
<b>P5</b>	CA502PP5	CA502MP5	CA502SP5	CA502PAP5
<b>X Small</b>	CA502PXS	CA502MXS	CA502SXS	CA502PAXS
<b>Small</b>	CA502PS	CA502MS	CA502SS	CA502PAS
<b>Small/Medium</b>	CA502PSM	CA502MSM	CA502SSM	CA502PASM
<b>Medium</b>	CA502PM	CA502MM	CA502SM	CA502PAM
<b>Medium/Large</b>	CA502PML	CA502MML	CA502SML	CA502PAML
<b>Large</b>	CA502PL	CA502ML	CA502SL	CA502PAL
<b>X Large</b>	CA502PXL	CA502MXL	CA502SXL	CA502PAXL
<b>CA503 Toilet Access with high back</b>				
<b>P1</b>	CA503PP1	CA503MP1	CA503SP1	CA503PAP1
<b>P2</b>	CA503PP2	CA503MP2	CA503SP2	CA503PAP2
<b>P3</b>	CA503PP3	CA503MP3	CA503SP3	CA503PAP3
<b>P4</b>	CA503PP4	CA503MP4	CA503SP4	CA503PAP4
<b>P5</b>	CA503PP5	CA503MP5	CA503SP5	CA503PAP5
<b>X Small</b>	CA503PXS	CA503MXS	CA503SXS	CA503PAXS
<b>Small</b>	CA503PS	CA503MS	CA503SS	CA503PAS
<b>Small/Medium</b>	CA503PSM	CA503MSM	CA503SSM	CA503PASM
<b>Medium</b>	CA503PM	CA503MM	CA503SM	CA503PAM
<b>Medium/Large</b>	CA503PML	CA503MML	CA503SML	CA503PAML
<b>Large</b>	CA503PL	CA503ML	CA503SL	CA503PAL
<b>X Large</b>	CA503PXL	CA503MXL	CA503SXL	CA503PAXL
<b>CA503E Toilet Access with high back extensor</b>				
<b>X Small</b>	CA503EPXS	n/a	n/a	n/a
<b>Small</b>	CA503EPS	n/a	n/a	n/a
<b>Medium</b>	CA503EPM	n/a	n/a	n/a
<b>Large</b>	CA503EPL	n/a	n/a	n/a
<b>X Large</b>	CA503EPXL	n/a	n/a	n/a
<b>CA600 Hammock</b>				
<b>P1</b>	CA600PP1	CA600MP1	CA600SP1	CA600PAP1
<b>P2</b>	CA600PP2	CA600MP2	CA600SP2	CA600PAP2
<b>P3</b>	CA600PP3	CA600MP3	CA600SP3	CA600PAP3
<b>P4</b>	CA600PP4	CA600MP4	CA600SP4	CA600PAP4
<b>P5</b>	CA600PP5	CA600MP5	CA600SP5	CA600PAP5
<b>X Small</b>	CA600PXS	CA600MXS	CA600SXS	CA600PAXS
<b>Small</b>	CA600PS	CA600MS	CA600SS	CA600PAS

<b>Small/Medium</b>	CA600PSM	CA600MSM	CA600SSM	CA600PASM
<b>Medium</b>	CA600PM	CA600MM	CA600SM	CA600PAM
<b>Medium/Large</b>	CA600PML	CA600MML	CA600SML	CA600PAML
<b>Large</b>	CA600PL	CA600ML	CA600SL	CA600PAL
<b>X Large</b>	CA600PXL	CA600MXL	CA600SXL	CA600PAXL
<b>CA700 Classic Hammock</b>				
<b>P1</b>	CA700PP1	CA700MP1	CA700SP1	CA700PAP1
<b>P2</b>	CA700PP2	CA700MP2	CA700SP2	CA700PAP2
<b>P3</b>	CA700PP3	CA700MP3	CA700SP3	CA700PAP3
<b>P4</b>	CA700PP4	CA700MP4	CA700SP4	CA700PAP4
<b>P5</b>	CA700PP5	CA700MP5	CA700SP5	CA700PAP5
<b>X Small</b>	CA700PXS	CA700MXS	CA700SXS	CA700PAXS
<b>Small</b>	CA700PS	CA700MS	CA700SS	CA700PAS
<b>Small/Medium</b>	CA700PSM	CA700MSM	CA700SSM	CA700PASM
<b>Medium</b>	CA700PM	CA700MM	CA700SM	CA700PAM
<b>Medium/Large</b>	CA700PML	CA700MML	CA700SML	CA700PAML
<b>Large</b>	CA700PL	CA700ML	CA700SL	CA700PAL
<b>X Large</b>	CA700PXL	CA700MXL	CA700SXL	CA700PAXL
<b>CA701 Deluxe Hammock</b>				
<b>P1</b>	CA701PP1	CA701MP1	CA701SP1	CA701PAP1
<b>P2</b>	CA701PP2	CA701MP2	CA701SP2	CA701PAP2
<b>P3</b>	CA701PP3	CA701MP3	CA701SP3	CA701PAP3
<b>P4</b>	CA701PP4	CA701MP4	CA701SP4	CA701PAP4
<b>P5</b>	CA701PP5	CA701MP5	CA701SP5	CA701PAP5
<b>X Small</b>	CA701PXS	CA701MXS	CA701SXS	CA701PAXS
<b>Small</b>	CA701PS	CA701MS	CA701SS	CA701PAS
<b>Small/Medium</b>	CA701PSM	CA701MSM	CA701SSM	CA701PASM
<b>Medium</b>	CA701PM	CA701MM	CA701SM	CA701PAM
<b>Medium/Large</b>	CA701PML	CA701MML	CA701SML	CA701PAML
<b>Large</b>	CA701PL	CA701ML	CA701SL	CA701PAL
<b>X Large</b>	CA701PXL	CA701MXL	CA701SXL	CA701PAXL
<b>CA701 Deluxe Hammock with head support</b>				
<b>P1</b>	CA701HSPP1	CA701HSMP1	CA701HSSP1	CA701HSPAP1
<b>P2</b>	CA701HSPP2	CA701HSMP2	CA701HSSP2	CA701HSPAP2
<b>P3</b>	CA701HSPP3	CA701HSMP3	CA701HSSP3	CA701HSPAP3
<b>P4</b>	CA701HSPP4	CA701HSMP4	CA701HSSP4	CA701HSPAP4
<b>P5</b>	CA701HSPP5	CA701HSMP5	CA701HSSP5	CA701HSPAP5
<b>X Small</b>	CA701HSPXS	CA701HSMXS	CA701HSSXS	CA701HSPAXS
<b>Small</b>	CA701HSPS	CA701HSMS	CA701HSSS	CA701HSPAS
<b>Small/Medium</b>	CA701HSPSM	CA701HSMSM	CA701HSSSM	CA701HSPASM
<b>Medium</b>	CA701HSPM	CA701HSMM	CA701HSSM	CA701HSPAM
<b>Medium/Large</b>	CA701HSPML	CA701HSMML	CA701HSSML	CA701HSPAML
<b>Large</b>	CA701HSPL	CA701HSML	CA701HSSL	CA701HSPAL

<b>X Large</b>	CA701HSPXL	CA701HSMXL	CA701HSSXL	CA701HSPAXL
<b>CA702 Comfort In Chair Hammock</b>				
<b>P1</b>	CA702PP1	CA702MP1	CA702SP1	CA702PAP1
<b>P2</b>	CA702PP2	CA702MP2	CA702SP2	CA702PAP2
<b>P3</b>	CA702PP3	CA702MP3	CA702SP3	CA702PAP3
<b>P4</b>	CA702PP4	CA702MP4	CA702SP4	CA702PAP4
<b>P5</b>	CA702PP5	CA702MP5	CA702SP5	CA702PAP5
<b>X Small</b>	CA702PXS	CA702MXS	CA702SXS	CA702PAXS
<b>Small</b>	CA702PS	CA702MS	CA702SS	CA702PAS
<b>Small/Medium</b>	CA702PSM	CA702MSM	CA702SSM	CA702PASM
<b>Medium</b>	CA702PM	CA702MM	CA702SM	CA702PAM
<b>Medium/Large</b>	CA702PML	CA702MML	CA702SML	CA702PAML
<b>Large</b>	CA702PL	CA702ML	CA702SL	CA702PAL
<b>X Large</b>	CA702PXL	CA702MXL	CA702SXL	CA702PAXL
<b>CA702 Comfort In Chair Hammock with head support</b>				
<b>P1</b>	CA702HSPP1	CA702HSMP1	CA702HSSP1	CA702HSPAP1
<b>P2</b>	CA702HSPP2	CA702HSMP2	CA702HSSP2	CA702HSPAP2
<b>P3</b>	CA702HSPP3	CA702HSMP3	CA702HSSP3	CA702HSPAP3
<b>P4</b>	CA702HSPP4	CA702HSMP4	CA702HSSP4	CA702HSPAP4
<b>P5</b>	CA702HSPP5	CA702HSMP5	CA702HSSP5	CA702HSPAP5
<b>X Small</b>	CA702HSPXS	CA702HSMXS	CA702HSSXS	CA702HSPAXS
<b>Small</b>	CA702HSPS	CA702HSMS	CA702HSSS	CA702HSPAS
<b>Small/Medium</b>	CA702HSPSM	CA702HSMSM	CA702HSSSM	CA702HSPASM
<b>Medium</b>	CA702HSPM	CA702HSMM	CA702HSSM	CA702HSPAM
<b>Medium/Large</b>	CA702HSPML	CA702HSMML	CA702HSSML	CA702HSPAML
<b>Large</b>	CA702HSPL	CA702HSML	CA702HSSL	CA702HSPAL
<b>X Large</b>	CA702HSPXL	CA702HSMXL	CA702HSSXL	CA702HSPAXL
<b>CA703 Split Leg In Chair Hammock</b>				
<b>P1</b>	CA703PP1	CA703MP1	CA703SP1	CA703PAP1
<b>P2</b>	CA703PP2	CA703MP2	CA703SP2	CA703PAP2
<b>P3</b>	CA703PP3	CA703MP3	CA703SP3	CA703PAP3
<b>P4</b>	CA703PP4	CA703MP4	CA703SP4	CA703PAP4
<b>P5</b>	CA703PP5	CA703MP5	CA703SP5	CA703PAP5
<b>X Small</b>	CA703PXS	CA703MXS	CA703SXS	CA703PAXS
<b>Small</b>	CA703PS	CA703MS	CA703SS	CA703PAS
<b>Small/Medium</b>	CA703PSM	CA703MSM	CA703SSM	CA703PASM
<b>Medium</b>	CA703PM	CA703MM	CA703SM	CA703PAM
<b>Medium/Large</b>	CA703PML	CA703MML	CA703SML	CA703PAML
<b>Large</b>	CA703PL	CA703ML	CA703SL	CA703PAL
<b>X Large</b>	CA703PXL	CA703MXL	CA703SXL	CA703PAXL

Table 8



## 6.0 DETACHABLE PARTS

Detachable parts that are included with the product consist of the Battery and the QRS (Quick Release System) Carry Bar. This is an optional accessory that is not included with the standard product.

Below are the instructions for attaching and detaching the QRS Carry Bar and the Battery.

### 6.1 Attaching/detaching QRS (Quick Release System) Carry Bar

If you have chosen to have QRS carry bar please follow the following section to attach and detach the carry bar from hoist. Attach the carry bar (type 'BF applied part) into the QRS Hook, located at the end of the boom, in the following way:

#### Attach

1. On the hook, move the locking mechanism into the hook by pressing down on the tab (Figure 30 and 31).
2. With the carry bar positioned sideways along the length of the bar, move the pin at the top of the carry bar into the hook (Figure 32).
3. Alternatively, with the carry bar positioned sideways, the pin at the top of the carry bar can gently push the locking mechanism out of the way as the pin is carefully moved into the hook.
4. Once the pin is in the hook, rotate the carry bar 90° down so the carry bar is hanging below the hook on the pin in the hook. Move the locking mechanism into place by pushing up on the tab, securing the carry bar on the hook and lifting tape. (Figure 33 and 34)

#### Detach

1. Press down on the locking mechanism as described in step 1 (Attach).
2. Rotate the Carry Bar to a sideways position and remove from the hook.



Figure 30

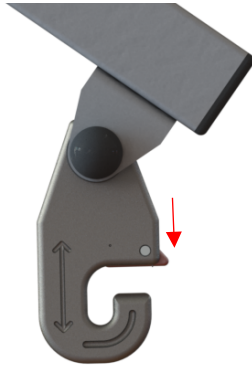

Figure 31

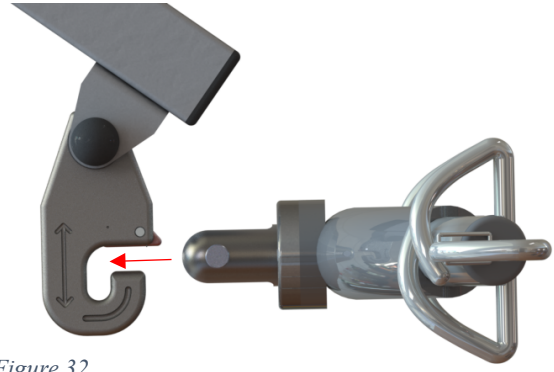

Figure 32



Figure 33

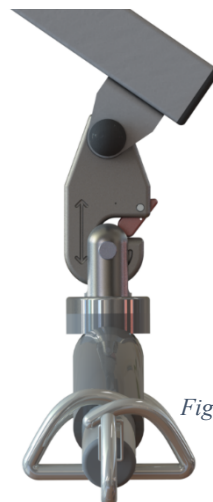

Figure 34



## 6.2 Attaching/detaching the Battery

The attachment and detachment of the Battery can be completed safely by following the following procedure:

### Attach

1. Grab Hold of the Battery from the top position as shown in figure 35 and place your fingers onto the latch.
2. Press the latch to release the Battery and lift the Battery from its fixing. (Figure 36)

### Detach

1. Place the Battery into the fixing location and push it forward into placement, the Battery will “click” into place.



Figure 35



Figure 36



Figure 37

## 7.0 TECHNICAL SPECIFICATION

### 7.1 Freeway M205 Mobile Hoist Dimensions

All dimensions below are shown in millimetres.

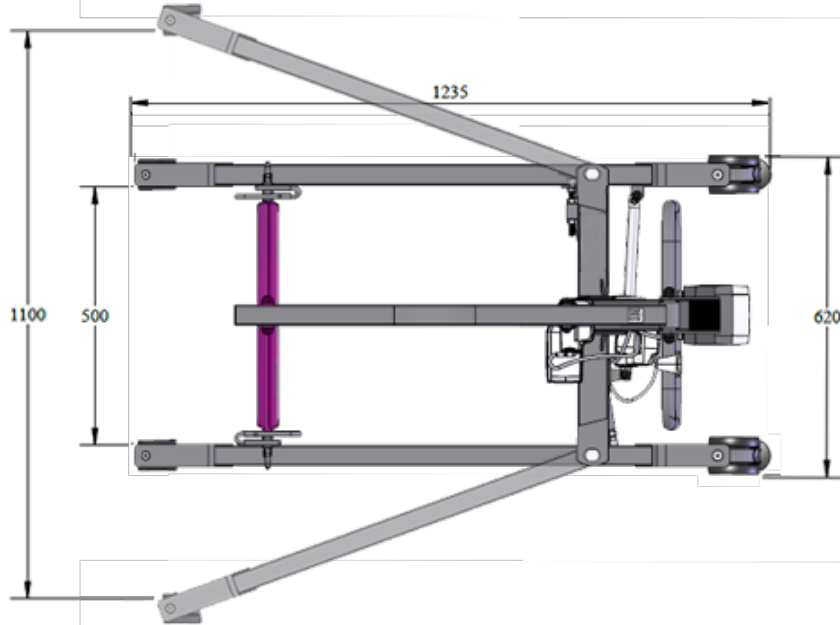

Figure 38

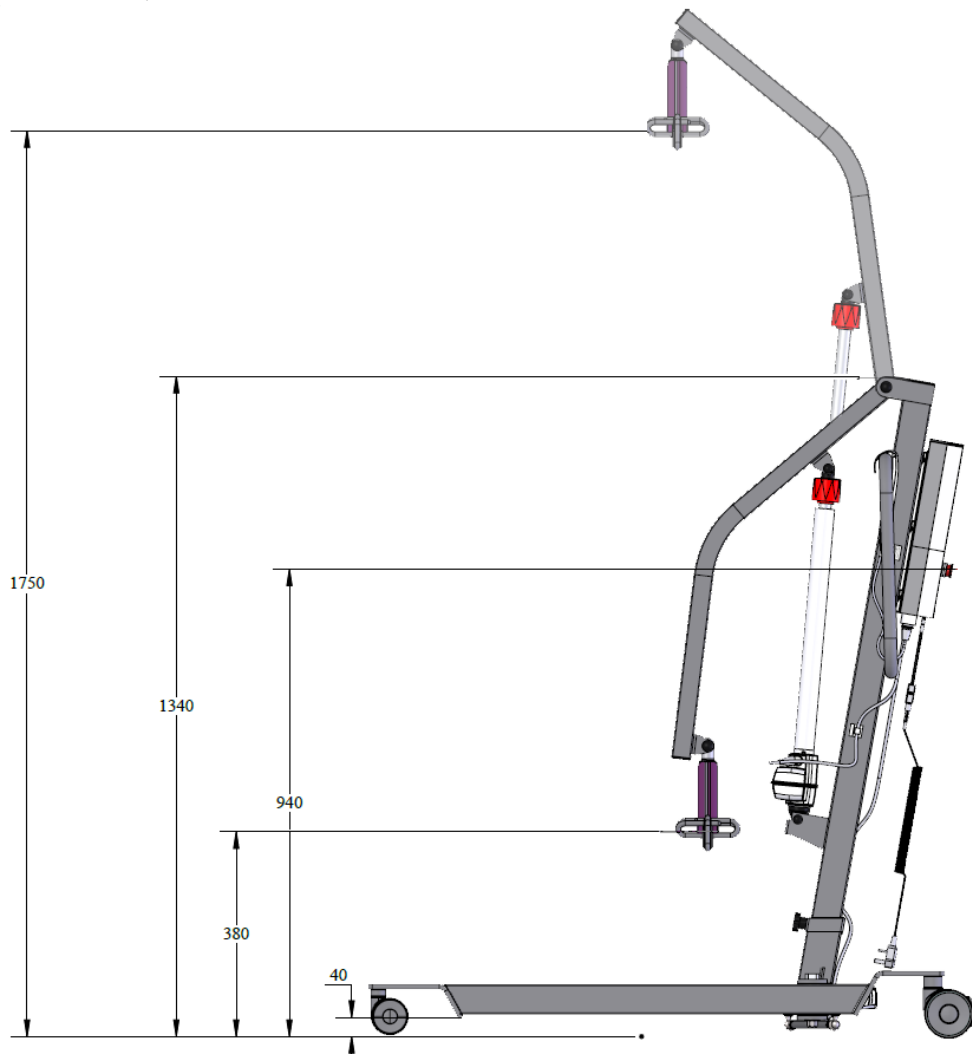

Figure 39

## 7.2 Specifications

Dimensions	
Turning Circle	1010mm
Overall Height	2010mm
Overall Width	625mm
Ground Clearance	15mm
Front and Rear Castors Size	75mm and 100mm

Table 9

Weights:	
Safe Working Load (SWL)	205 kg
Full Product	40 kg
Base Assembly	18.5 kg
Mast & Boom Assembly	21.5 kg

Table 10

Operational Forces	
Moving Force (with 205 kg)	83 N
Moving Force (with 0 kg)	16 N
Operation of the Brake	35 N
Handset	4.5 N
E-Stop Button	12 N
Carry Bar Rotation (205 kg)	18 N
Carry Bar Rotation (0 kg)	< 0.5 N

Table 11

Sound Levels	Loaded dB(a)	Unloaded dB(a)
Lifting	41.7	38.5
Lowering	40.9	30.5

Table 12

## 7.3 Electrical Specifications

<b>Battery type:</b>	2 x 12-volt Rechargeable sealed lead acid.
<b>Battery capacity:</b>	24 V DC, 1 x 2.9 Ah
<b>Charger rated input:</b>	230VAC 50/60Hz
<b>Charger rated output:</b>	27.4/29.0 VDC @ 0.8A

### Electric Shock Protection

<b>Charger:</b>	Class II *Lift - internal power source
<b>Degree of shock protection:</b>	Type B *Lift - internal power source
<b>Duty cycle:</b>	10% Use – 90% Rest (90 seconds use - 810 seconds rest)
<b>IP rating, control box:</b>	IPX4
<b>IP rating, battery:</b>	IPX5
<b>IP rating, handset:</b>	IPX4

### Expected Product Lifetime

10 yrs. depending usage and compliance to maintenance, servicing and LOLER inspections.

## 7.4 Standards Applied

The standards that have been applied to the device are as follows:

- EN 10535:2006 Hoists for the transfer of disabled persons. Requirement and test methods

## 8.0 ENVIRONMENTAL - STORAGE AND OPERATING CONDITIONS

The Freeway M205 is intended for internal use within normal environmental conditions.



It is not intended to be used in environments where there are rapid changes in the environmental temperature and humidity during use.

### 8.1 Normal Operating Conditions

+5°C to +40°C (41°F to 104°F) at a relative humidity between 15% to 90% RH, non-condensing but not requiring a water vapour pressure greater than 50hPa and atmospheric pressure between 700hPa to 1060hPa.

### 8.2 Shipping and storage conditions

-25°C to +5°C (-13°F to 41°F) with any humidity level.

+5°C to +35°C (41°F to 95°F) at a relative humidity up to 90%.

+35°C to 70°C (95°F to 158°F) non-condensing at a water vapour pressure up to 50hPa.

## 9.0 DISPOSAL



When the Hoist has completed its life cycle and can no longer perform to its intended use safely the Hoist must be decommissioned by an approved Service Engineer. The following specifies the importance of correct disposal procedure including local laws and being environmentally friendly.

Please observe the local laws on recycling and respect the current laws for disposal within the community the device is being used within. If there is any uncertainty of the below guidelines, contact your local authorities to determine the proper method of disposal of potentially biohazardous parts and accessories.

The relevant components utilised in the manufacture of the device that can be recycled at the end of the device life are:

Fully recyclables:	Consideration when Recycling:
Steel frame (Mast, Boom, Base, Legs)	Carry Bar Cover
Castors	Leg Actuator
Initial packaging of the device (cardboard)	Lift Actuator
Metallic fixing – screws etc.	Handset + Cables
Carry Bar	Control Box
	Battery

Table 13



The product may be contaminated and has to be disinfected before recycling or disposal. See section 11.3 'Cleaning' for details of how to do this.

## 10.0 FAULT FINDING

If a problem arises with the Mobile Hoist, the Table below will hopefully assist in determining the fault and what actions you can take. If the fault cannot be found or the fault is found and the action guide does not provide a fix (e.g. – a damaged wire would need replacement), contact your local Prism Medical UK authorised dealer immediately, a service engineer will be required to repair the Hoist. Contact details can be found on the last page of this manual.

Fault	Action
Hoist doesn't turn on	<ul style="list-style-type: none"> <li>• Check the E-Stop button on the control box has not been activated.</li> <li>• Check the Handset is correctly connected to the correct control box port.</li> <li>• Check the Handset lead is not damaged, e.g. cuts and breaks.</li> <li>• Check to see if Hoist battery is out of charge and requires charging.</li> <li>• Check the Battery is located correctly on top of the control box.</li> <li>• Check for any damage to the battery terminals, e.g. burns and breaks.</li> <li>• Perform a visual check on the Control box for any damage.</li> </ul>
Hoist doesn't charge	<ul style="list-style-type: none"> <li>• Check the Charger plug is turned on at the power supply.</li> <li>• Check that the Charger Lead is connected correctly to the Control Box</li> <li>• Check charging lead for damage, e.g. cuts and breaks.</li> <li>• Check that the Battery is connected properly with the Control Box.</li> <li>• Inspect the Battery terminals for any damage, e.g. burns and breaks.</li> <li>• Inspect the Control Box terminals for any damage, e.g. burns and breaks</li> </ul>
Hoist doesn't lift	<ul style="list-style-type: none"> <li>• Check if the Hoist is plugged into Charge. (Hoist will not raise and lower while on charge)</li> <li>• Check that the Lift Actuator to Control Box cable is connected properly between the two ports.</li> <li>• Check the Lift Actuator to Control Box cable for damage, e.g. cuts and breaks.</li> <li>• Inspect the Lift Actuator for any signs of damage which could affect its function, including the Port. E.g. Large Cracks and breaks, electrical burns.</li> <li>• Inspect the Control Box Port for any damage. E.g. electrical burns, breaks.</li> </ul>
Hoist is functioning but LCD and/or LED is inactive	<ul style="list-style-type: none"> <li>• Check LCD Display or LED externally for any impact damage, e.g. cracks or breaks.</li> <li>• Control Box/handset is damaged</li> </ul>
Hoist Leg Actuator is not responding	<ul style="list-style-type: none"> <li>• Check Cable between the Control Box and the Leg Actuator is connected correctly.</li> <li>• Check for Cable damage between the Control Box and Leg Actuator cable.</li> <li>• Inspect the Leg Actuator for any damage, including the cable port. E.g. large cracks and electrical burns.</li> <li>• Inspect the Control Box Leg Actuator Cable Port for any damage. E.g. cracks and electrical burns.</li> <li>• If there is no indication of any power while commanding the Powered Legs, Handset buttons could be damaged.</li> </ul>
Hoist has power but does not respond to handset commands	<ul style="list-style-type: none"> <li>• Check the Handset is correctly connected to the Control Box.</li> <li>• Check that the Lift Actuator and Leg Actuator Cables are both connected to the Control Box.</li> <li>• Check the Handset cable is not damaged, e.g. cuts and breaks.</li> <li>• Check the Lift Actuator and Leg Actuator Cables for damage, e.g. cuts and breaks</li> <li>• Check the Control Box Handset Port for any damage. E.g. cracks and electrical burns.</li> </ul>

Table 14

## 11.0 GENERAL INSPECTION, MAINTENANCE AND CLEANING

### 11.1 Service



No service is to be carried out on the M205 Mobile Hoist, while transferring a person to reduce the risk of injury. Service must be completed by a Prism Medical UK authorised Service Engineer. Do not attempt to service the product yourself, or warranty is void.

To ensure the safety and continued good function of your Hoist, routine service must be performed on your Freeway M205 Mobile Hoist.

Service should be completed by a Prism Medical UK approved service engineer every 6 months to ensure the products required standard is maintained. The service history of the product should be documented each service in the Service Log at the back of this User Manual.



When the Mobile Hoist is serviced, the 6 month service checklist must be completed for the Freeway M205 Mobile Hoist.

Service Manual Document Number: 995069.

Spare Parts Manual Document Number 992069.

The Service must be completed every 6 months after installation of the Hoist to comply with LOLER Regulations. The Freeway M205 Mobile Hoist has an expected Service Life of 10 Years.

Contact your local authorised Prism Medical UK dealer if you:

- Need more information.
- Have any questions about the use or service of your Mobile Hoist.
- Notice any change in the performance.
- Want to report an unexpected occurrence.
- Want to arrange a service.
- Need to ascertain necessary information for replacement parts and components.

Contact details of your local Prism Medical UK dealer are shown on the last page of this manual.

## 11.2 Inspection

Inspection is to be completed prior to each use by the user of the Mobile Hoist.



Should any of the components in the table below fail the inspection, DO NOT use the Mobile Hoist. Contact your local authorized dealer for service – contact details are on the last page of this manual.

Ensure all component inspections in the Table below are completed prior to each use of the Hoist.

### Check List before Use

Component	Service/Inspection required
<b>Generic</b>	Visual inspection of the external of the Mobile Hoist. Significant damage that may affect the function of the Mobile Hoist along with a clear safety hazard is unacceptable.
	Check the Labelling on the Mobile Hoist to ensure they are all still legible, this includes the Serial Number and other important markings. If labels are not legible, then contact your local authorised dealer immediately.
	Check all main nuts and bolts to see if they are loose, If they are not tight or you have concerns, then contact your local authorised dealer immediately.
<b>Certification</b>	An authorised/competent service company or person will issue a test certificate after satisfactory completion of the LOLER inspection. The certificate will be valid for 6 months.
<b>Battery Pack</b>	The battery pack should not require maintenance other than the regular charging as detailed in the charging instructions.
<b>Emergency Stop Button</b>	Check the emergency stop button functionality
<b>Manual Emergency Lower</b>	Check the manual emergency lower functionality.
<b>Actuator</b>	The actuator should not require maintenance other than checking for correct operation, listening for unusual noise and checking for any damage.
<b>Leg Actuator</b>	The actuator should not require maintenance other than checking for correct operation, listening for unusual noise and checking for any damage.
<b>Castors</b>	Check the brake functionality on each rear castor. Check all castor fixing points. Check that each castor runs free and rotates easily. Remove any build-up of hair, fluff, dust etc.
<b>Leg Pivot Points</b>	Check the smooth opening and closing of the legs.
<b>Control Box</b>	Inspect all male plugs and female sockets for correct fitting. Inspect the hand control functionality.
<b>Mast</b>	Ensure the mast fully engages into the base housing. Check the operation of the mast locking hand wheel. Check the actuator mounting brackets for excessive wear.
<b>Boom</b>	Check the attachment of the boom to the mast, ensure all fixing points are secure and free from wear.
<b>Carry Bar</b>	Check the carry bar rotates and swings freely. Check the central pivot bolt and nylon lock nut for excessive wear. Check the fixing point for excessive wear and inspect the sling hooks for any damage, sharp edges and excessive wear.
	Inspect Carry Bar wear washer, ensure the washer has not fully worn, if so, replacement is required.

Table 15

## 11.3 Cleaning

Please follow the cleaning guidelines below on cleaning and disinfecting the Hoist.

### 11.3.1 General cleaning



It is recommended to clean the Freeway M205 and accessories before the use by a different patient, reducing the risk of cross-contamination.

The exterior of the Freeway M205 can be cleaned using a damp soapy cloth for general cleaning duties. Please ensure the cloth is damp and not wet. Ensure the exterior of the device is dry after cleaning. Dry using a clean dry cloth.

### 11.3.2 Disinfecting (if necessary)

Should the Mobile Hoist require a more thorough clean, the use of the Actichlor™ disinfectant product (which is widely available in tablet form and used throughout the health care industry) is recommended.



Follow the manufacturer's safety instructions for the use of the cleaning product before use to ensure safe use for the operator and the patient.

Ensure the cloth is damp before the cleaning process.

Application is through a clean damp cloth applied to wipe the device down. Use in the following dilutions to ensure an effective clean:

- Actichlor™ dissolvable chlorine tablets provide a concentration of 1000 ppm of available chlorine (0.1%) per 1 tablet
- 1 tablet (1.7g formed tablet (x1)) will create a virucidal solution, diluted in 1 litre of water to provide effective means to clean a "dirty" device. This is also ideal for use after an outbreak of the Norovirus/winter vomiting and can be used as a precaution against C.Diff. It is effective against viruses, bacteria, spores, yeasts and moulds.
- The contact time against the outer components of the device should be for 5 minutes to prevent any virucidal infections without a degradation to the functionality of the device. 5 minutes is a recommended contact time. The device can withstand a longer contact period but the 5 minute recommendation as a minimum must be followed to provide an effective cleaning regime.
- Blood spills should be dealt with by an increased concentration of the solution – please refer to the instructions on the manufacturers product labelling.



Dilution chart					
Product used as	Device condition	Concentration (ppm)	Dilution qty* (l)	Tablets per 1l (0.26gal)	Contact time (minutes)
<b>Bactericidal</b>	Clean	200	5 (1.32gal)	1	1
	Dirty	1000	1 (0.26gal)	1	5
<b>Yeasticidal</b>	Clean	200	5 (1.32gal)	1	1
	Dirty	1000	1 (0.26gal)	1	5
<b>Fungicidal</b>	Clean	2000	1 (0.26gal)	2	15
	Dirty	5000	1 (0.26gal)	5	15
<b>Mycrobactericidal</b>	Clean	1000	1 (0.26gal)	1	15
	Dirty	5000	1 (0.26gal)	5	15
<b>Virucidal</b>	Clean	500	2 (0.53gal)	1	5
	Dirty	1000	1 (0.26gal)	1	5
<b>Sporcidal (C.Diff)</b>	Clean	1000	1 (0.26gal)	1	10
	-	-	-	-	-
<b>Sporcidal</b>	Clean	5000	1 (0.26gal)	5	10
	-	-	-	-	-

\* Dilution is made with water. DO NOT dilute within any other medium.

- When diluted in water, one tablet gives 1000ppm of available chlorine.
- The concentration of the solution depends upon whether the object being cleaned is noticeably dirty (indicated in the table by "Device condition").

Table 15

**Handling and storage safety precautions when using this cleaning agent:**

**Advice on Safe Handling**



- Avoid contact with skin and eyes.
- Do not breathe dust/fumes/gas/mist/vapours/spray.
- Use only with adequate ventilation.
- Wash hands thoroughly after handling.
- Mixing this product with acid or ammonia releases chlorine gas.

**Hygiene Measures**

Handle in accordance with good industrial hygiene and safety practice. Remove and wash contaminated clothing before re-use. Wash face, hands and any exposed skin thoroughly after handling.

**Conditions for Safe Storage**



- Keep out of reach of children.
- Keep container tightly closed.
- Store in suitable labelled containers.
- Storage temperature: 0-25°C (32-77°F).

**Individual Protective Measures**

Hand protection: Gloves

**Dissolve**

Dissolve in cold water – With no agitation, 1 tablet will take approximately 10 minutes to fully dissolve in the water used.

The information above has been extracted from the Actichlor™ MSDS (Manufacturers Safety Data Sheet). For a full review of the data please follow the link below:

<http://www.nhsggc.org.uk/media/236215/msds-actichlor-plus.pdf>

## 12.0 WARRANTY

This guarantee does not affect or in any way limit your Statutory Rights.

1. Prism Medical UK guarantees the M205, supplied as new, against failure within the period of 36 months from the date of purchase by virtue of defects in material or workmanship. (Excluding Batteries)
2. The liability of Prism Medical UK under terms of this guarantee shall be limited to the replacement or the defective part(s) to the sales distributor, dealer, agent, person or entity which purchased the equipment from Prism Medical UK. In no event shall Prism Medical UK incur liability for any consequential or unforeseeable losses.
3. This equipment guarantee shall be void if the equipment is not serviced by Prism Medical UK or its authorised agents, in accordance with manufacturer's recommendations, or if any unauthorized persons carry out work on the equipment.
4. This guarantee does not apply to failure attributable to normal wear and tear, damage by natural forces, user neglect or misuse or to deliberate destruction.
5. Do not attempt to service the product yourself, or warranty is void.
6. Removal of the warranty label on the side of the control box will result in the Warranty becoming void.

### 13.0 SERVICE RECORD HISTORY

Complete this section after each service, repair inspection and/or maintenance.

Date: _____	Time: _____
Service Type: <input type="checkbox"/> Periodic inspection <input type="checkbox"/> Monthly inspection <input type="checkbox"/> 6-month inspection <input type="checkbox"/> Repair <input type="checkbox"/> Yearly inspection <input type="checkbox"/> Other	
Completed by: ..... (printed name). ..... (signature)	
Company: .....	
Remarks & Action Taken:	
Device left in a safe usable condition: YES. <input type="checkbox"/> NO <input type="checkbox"/> (if "NO" explain in remarks the action taken)	

Date: _____	Time: _____
Service Type: <input type="checkbox"/> Periodic inspection <input type="checkbox"/> Monthly inspection <input type="checkbox"/> 6-month inspection <input type="checkbox"/> Repair <input type="checkbox"/> Yearly inspection <input type="checkbox"/> Other	
Completed by: ..... (printed name). ..... (signature)	
Company: .....	
Remarks & Action Taken:	
Device left in a safe usable condition: YES. <input type="checkbox"/> NO <input type="checkbox"/> (if "NO" explain in remarks the action taken)	

Date: _____	Time: _____
Service Type: <input type="checkbox"/> Periodic inspection <input type="checkbox"/> Monthly inspection <input type="checkbox"/> 6-month inspection <input type="checkbox"/> Repair <input type="checkbox"/> Yearly inspection <input type="checkbox"/> Other	
Completed by: ..... (printed name). ..... (signature)	
Company: .....	
Remarks & Action Taken:	
Device left in a safe usable condition: YES. <input type="checkbox"/> NO <input type="checkbox"/> (if "NO" explain in remarks the action taken)	

Date: _____	Time: _____
Service Type: <input type="checkbox"/> Periodic inspection <input type="checkbox"/> Monthly inspection <input type="checkbox"/> 6-month inspection <input type="checkbox"/> Repair <input type="checkbox"/> Yearly inspection <input type="checkbox"/> Other	
Completed by: ..... (printed name). ..... (signature)	
Company: .....	
Remarks & Action Taken:	
Device left in a safe usable condition: YES. <input type="checkbox"/> NO <input type="checkbox"/> (if "NO" explain in remarks the action taken)	

Date: _____	Time: _____
Service Type: <input type="checkbox"/> Periodic inspection <input type="checkbox"/> Monthly inspection <input type="checkbox"/> 6-month inspection <input type="checkbox"/> Repair <input type="checkbox"/> Yearly inspection <input type="checkbox"/> Other	
Completed by: ..... (printed name). ..... (signature)	
Company: .....	
Remarks & Action Taken:	
Device left in a safe usable condition: YES. <input type="checkbox"/> NO <input type="checkbox"/> (if "NO" explain in remarks the action taken)	

Date: _____	Time: _____
Service Type: <input type="checkbox"/> Periodic inspection <input type="checkbox"/> Monthly inspection <input type="checkbox"/> 6-month inspection <input type="checkbox"/> Repair <input type="checkbox"/> Yearly inspection <input type="checkbox"/> Other	
Completed by: ..... (printed name). ..... (signature)	
Company: .....	
Remarks & Action Taken:	
Device left in a safe usable condition: YES. <input type="checkbox"/> NO <input type="checkbox"/> (if "NO" explain in remarks the action taken)	

Date: _____	Time: _____
Service Type: <input type="checkbox"/> Periodic inspection <input type="checkbox"/> Monthly inspection <input type="checkbox"/> 6-month inspection <input type="checkbox"/> Repair <input type="checkbox"/> Yearly inspection <input type="checkbox"/> Other	
Completed by: ..... (printed name). ..... (signature)	
Company: .....	
Remarks & Action Taken:	
Device left in a safe usable condition: YES. <input type="checkbox"/> NO <input type="checkbox"/> (if "NO" explain in remarks the action taken)	

Date: _____	Time: _____
Service Type: <input type="checkbox"/> Periodic inspection <input type="checkbox"/> Monthly inspection <input type="checkbox"/> 6-month inspection <input type="checkbox"/> Repair <input type="checkbox"/> Yearly inspection <input type="checkbox"/> Other	
Completed by: ..... (printed name). ..... (signature)	
Company: .....	
Remarks & Action Taken:	
Device left in a safe usable condition: YES. <input type="checkbox"/> NO <input type="checkbox"/> (if "NO" explain in remarks the action taken)	

Date: _____	Time: _____
Service Type: <input type="checkbox"/> Periodic inspection <input type="checkbox"/> Monthly inspection <input type="checkbox"/> 6-month inspection <input type="checkbox"/> Repair <input type="checkbox"/> Yearly inspection <input type="checkbox"/> Other	
Completed by: ..... (printed name). ..... (signature)	
Company: .....	
Remarks & Action Taken:	
Device left in a safe usable condition: YES. <input type="checkbox"/> NO <input type="checkbox"/> (if "NO" explain in remarks the action taken)	

Date: _____	Time: _____
Service Type: <input type="checkbox"/> Periodic inspection <input type="checkbox"/> Monthly inspection <input type="checkbox"/> 6-month inspection <input type="checkbox"/> Repair <input type="checkbox"/> Yearly inspection <input type="checkbox"/> Other	
Completed by: ..... (printed name). ..... (signature)	
Company: .....	
Remarks & Action Taken:	
Device left in a safe usable condition: YES. <input type="checkbox"/> NO <input type="checkbox"/> (if "NO" explain in remarks the action taken)	

Date: _____	Time: _____
Service Type: <input type="checkbox"/> Periodic inspection <input type="checkbox"/> Monthly inspection <input type="checkbox"/> 6-month inspection <input type="checkbox"/> Repair <input type="checkbox"/> Yearly inspection <input type="checkbox"/> Other	
Completed by: ..... (printed name). ..... (signature)	
Company: .....	
Remarks & Action Taken:	
Device left in a safe usable condition: YES. <input type="checkbox"/> NO <input type="checkbox"/> (if "NO" explain in remarks the action taken)	

Date: _____	Time: _____
Service Type: <input type="checkbox"/> Periodic inspection <input type="checkbox"/> Monthly inspection <input type="checkbox"/> 6-month inspection <input type="checkbox"/> Repair <input type="checkbox"/> Yearly inspection <input type="checkbox"/> Other	
Completed by: ..... (printed name). ..... (signature)	
Company: .....	
Remarks & Action Taken:	
Device left in a safe usable condition: YES. <input type="checkbox"/> NO <input type="checkbox"/> (if "NO" explain in remarks the action taken)	

Date: _____	Time: _____
Service Type: <input type="checkbox"/> Periodic inspection <input type="checkbox"/> Monthly inspection <input type="checkbox"/> 6-month inspection <input type="checkbox"/> Repair <input type="checkbox"/> Yearly inspection <input type="checkbox"/> Other	
Completed by: ..... (printed name). ..... (signature)	
Company: .....	
Remarks & Action Taken:	
Device left in a safe usable condition: YES. <input type="checkbox"/> NO <input type="checkbox"/> (if "NO" explain in remarks the action taken)	

Date: _____	Time: _____
Service Type: <input type="checkbox"/> Periodic inspection <input type="checkbox"/> Monthly inspection <input type="checkbox"/> 6-month inspection <input type="checkbox"/> Repair <input type="checkbox"/> Yearly inspection <input type="checkbox"/> Other	
Completed by: ..... (printed name). ..... (signature)	
Company: .....	
Remarks & Action Taken:	
Device left in a safe usable condition: YES. <input type="checkbox"/> NO <input type="checkbox"/> (if "NO" explain in remarks the action taken)	

Date: _____	Time: _____
Service Type: <input type="checkbox"/> Periodic inspection <input type="checkbox"/> Monthly inspection <input type="checkbox"/> 6-month inspection <input type="checkbox"/> Repair <input type="checkbox"/> Yearly inspection <input type="checkbox"/> Other	
Completed by: ..... (printed name). ..... (signature)	
Company: .....	
Remarks & Action Taken:	
Device left in a safe usable condition: YES. <input type="checkbox"/> NO <input type="checkbox"/> (if "NO" explain in remarks the action taken)	

User notes:

Empty rectangular box for user notes.

Dealer/service contact details:

### Contact Us

Units 5 and 6 Lower Vicarage  
Road  
Southampton  
Hampshire  
SO19 7RJ  
T: 02380 420678  
E: [info@easycare systems.co.uk](mailto:info@easycare systems.co.uk)



[www.easycare systems.co.uk](http://www.easycare systems.co.uk)

