

# User Manual Hi-Riser Changing Bench

# CONTENTS

## Contents

1.0	Safety Instructions and Warnings.....	4
1.1	Introduction .....	4
1.2	Service and Support .....	4
1.3	Symbols Used.....	5
1.4	Contraindications/Limitations .....	5
1.5	Intended Use .....	6
1.5.1	Intended User.....	6
1.6	Changing Bench Operating Environment.....	6
1.6.1	Frequency of use:.....	6
1.7	Changing Bench Essential Performance .....	6
1.8	Vicinity to Other Equipment .....	7
1.9	Incident Reporting.....	7
1.10	Additional Warnings and Safety Notices.....	7
2.0	Components/Key Parts .....	8
2.1	Key Parts .....	8
2.2	Packaging.....	8
3.0	Installation.....	9
3.1	Surveying Procedure .....	9
3.2	Installation Tools Required .....	9
3.3	Installation Procedure .....	10
3.4	Adjustments .....	13
4.0	Technical Specification .....	14
4.1	Changing Bench Dimensions.....	14
4.2	Environmental - Storage and Operating Conditions.....	15
4.2.1	Normal operating conditions.....	16
4.2.2	Shipping and storage conditions .....	16
4.3	Standards Applied.....	16
4.4	Disposal.....	17
5.0	General Inspection and Maintenance.....	18
5.1	Daily Checks - To Be Completed by User.....	18
5.2	Service Interval .....	18
5.3	Nominal Service Life .....	18
5.4	Extending Nominal Service Life .....	19
5.5	User Serviceable Parts .....	19
5.6	Final Inspection.....	19
6.0	Cleaning .....	20
6.1	General cleaning.....	20

# CONTENTS

7.0	Service Documentation .....	21
7.1	Documentation/ Records .....	21
7.2	Service Record History .....	22
7.2.1	Product Information .....	22
7.2.2	Service & inspection record form:.....	22



## 1.0 SAFETY INSTRUCTIONS AND WARNINGS

### 1.1 Introduction

The information in this manual is important to your safety.



Please read and understand this manual in its entirety before using your Hi-Riser Changing Bench.

**If you require larger print or videos – these are available on the Smirthwaite website:  
[www.smirthwaite.co.uk/product/Hi-Riser-Changing-Bench/](http://www.smirthwaite.co.uk/product/Hi-Riser-Changing-Bench/)**

The information in this manual is important for the safety of anyone near the Hi-Riser Changing Bench and must be read and understood to help prevent injuries. It is also crucial to the proper operation and maintenance of the Hi-Riser Changing Bench.

Store this manual with the documents included with the Changing Bench. The Hi-Riser Changing Bench is designed to be used in conjunction with approved accessories. Please refer to any user guides supplied with these components while reviewing this manual.

Contents of this manual are subject to change without prior notice.



Unauthorised modifications on any Smirthwaite product may affect its safety. The manufacturer will not be held responsible for any accident, incident or deficiencies of performance that occur as a result of any unauthorised modification to its products.

### 1.2 Service and Support

To ensure the safety and continued good function of your product, routine service must be performed on your Hi-Riser Changing Bench.

For further details, see section 5.0 General Inspection and Maintenance.

As well as inspections and simple checks completed by the user, every 1 year a service must be completed by Smirthwaite Ltd authorised trained service staff.

















Contact your local authorised Smirthwaite dealer if you:

- Need more information.
- Have any questions about the use or maintenance of your Hi-Riser Changing Bench.
- Notice any change in the performance of your Changing Bench.
- Want to report an unexpected occurrence.
- Want to arrange a service.

Contact details of your local Smirthwaite dealer are shown on the last page of this manual.

# SAFETY INSTRUCTIONS AND WARNINGS

## 1.3 Symbols Used

	Consult instructions before use		Caution
	Class II Equipment - electrical equipment in which protection against electric shock does not rely on basic insulation only	<b>SWL</b>	Safe Working Load represents the maximum load rated for safe operation
	Manufacturer		Date of manufacture
	Packaging indicator – This way up		Packaging indicator – Keep dry
	Serial number		For internal use only
	Please observe local laws on recycling	<b>IP<sub>N<sub>1</sub></sub>N<sub>2</sub></b>	Degree of protection provided by enclosure. N <sub>1</sub> : Ingress of particles N <sub>2</sub> : Ingress of water
	Temperature range		Humidity range
	Type 'B' applied part		Type 'BF' applied part
	Medical Device		Authorised representative in the European Community

## 1.4 Contraindications/Limitations

There are no known “contraindications” associated with the usage of the Hi-Riser Changing Bench and its accessories, provided they are used as per manufacturer’s recommendations and guidelines.

Smirthwaite Ltd. does not recommend a required number of care givers for the use of our products. This information and recommendation can only be provided after a thorough

# SAFETY INSTRUCTIONS AND WARNINGS

personalised, case specific assessment, as there are many factors that can influence these decisions.

## 1.5 Intended Use



For internal use only.

Intended to support a recumbent patient for changing purposes

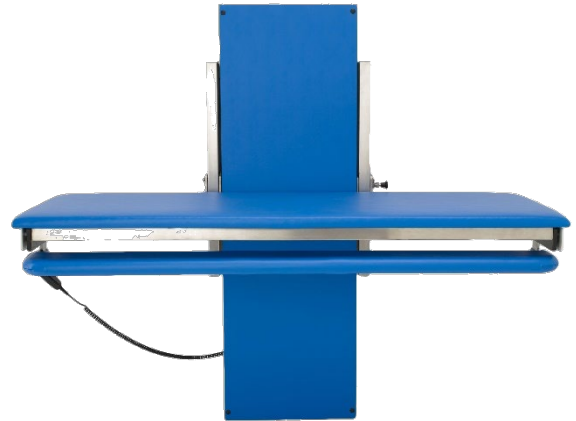

### 1.5.1 Intended User

The Hi-Riser has been designed for use by a child's carer, therapist, and/or teaching staff who will maintain and clean the Changing Bench as per the recommended guidelines in section 6.0 Cleaning.

The Hi-Riser is designed to be checked and adjusted by a therapist to ensure the child is positioned correctly.

## 1.6 Changing Bench Operating Environment

The Hi-Riser Changing Bench is suitable for use within the professional health care facility environment as well as the home health care environment.

The Changing Bench is not intended to be used in environments where there are rapid changes in the environmental temperature and humidity during intended use.

The Hi-Riser is intended for indoor use only; the normal operating conditions are as follows:

- A. Temperature: 41°F to 86°F (+5°C to 40°C)
- B. Relative Humidity: 15 to 90%, non-condensing, but not requiring a water vapour pressure greater than 50hPa.
- C. Atmospheric Pressure: 700hPa to 1060hPa.
- D. Ambient luminance 50 – 500 lux.
- E. Viewing distance: 0 metre to 1.5 metre

### 1.6.1 Frequency of use:

The Hi-Riser can be used without any frequency restrictions.

## 1.7 Changing Bench Essential Performance

The essential performance of the Changing Bench is defined as:

Indicated for use by anyone weighing 200kg or less requiring assistance to change due to disability, injury or age-related immobility.

## 1.8 Vicinity to Other Equipment

Use of this equipment stacked with other equipment should be avoided, unless the equipment is an approved accessory.

Contact your local authorised dealer if assistance is required – contact details on the last page of this manual.

## 1.9 Incident Reporting

If, during the use of this device or as a result of its use a serious incident has occurred, please report it to the manufacturer and the competent authority of the member state in which the user and/or patient is established.

## 1.10 Additional Warnings and Safety Notices

- DO NOT attempt to install and use this product in a wet room. Please follow installation instructions as described in Section 5 carefully and thoroughly.
- The user should NOT be left unattended whilst on the changing table. Always ensure a responsible therapist or carer is in attendance.
- The Hi-Riser changing table height should NEVER be adjusted without a carer in attendance.
- Always ensure the safety side is in the 'up' position once a patient is on the table.
- When storing the product vertically (up position), check to ensure that the locking plunger pin is fully engaged.
- When not in use for periods of time, isolate the electrical supply.
- Always keep this product away from naked flames, cigarettes and sources of heat including open fireplaces, radiators and heaters.
- Regular maintenance checks and cleaning are essential for the safe use of this equipment (see care and maintenance section).
- DO NOT fit parts or accessories of other manufacturers to this product unless authorised to do so in writing by G&S Smirthwaite Ltd. Failure to follow these instructions will not only invalidate the guarantee but could make the product dangerous to use. G&S Smirthwaite Ltd will not accept liability for any injury or damage incurred through such malpractices. Any repairs required must be carried out by G&S Smirthwaite Ltd authorised personnel.
- If any part is loose, damaged or functioning incorrectly, DO NOT use until rectified.
- The Hi-Riser changing table is CE marked. This certifies that it meets all relevant European safety requirements.
- If you believe the product or any fitted accessory to be faulty at any time, DO NOT USE – contact Easy Care Systems by telephone on +44 (0) 2380 420678

## 2.0 COMPONENTS/KEY PARTS

### 2.1 Key Parts

When delivered, the Changing Bench will be supplied fully assembled. Always turn hand wheels, levers and screws clockwise to tighten or anti-clockwise to loosen. Conveniently packaged in a single box, the following components are included with your new Hi-Riser Changing Bench:

Item	Description
A	Safety Side
B	Bed
C	Wall Frame
D	Handset

Table 1

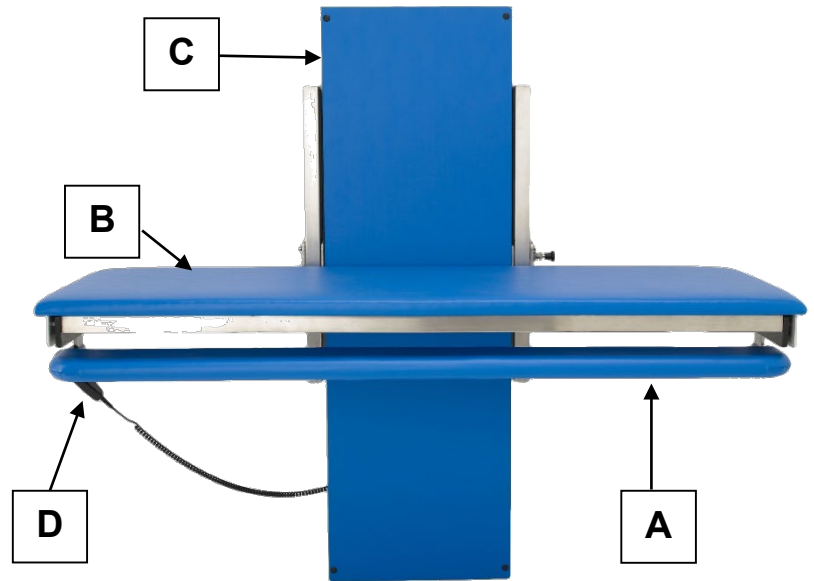

### 2.2 Packaging

- When delivered, the Changing Bench will be supplied fully assembled.
- If your order has been supplied as a custom kit, please ensure you follow both the instructions documented in this User Manual **and** any additional instructions supplied.
- Please take note of any instructions on the packaging/box when unpacking.
- Once the Changing Bench has been carefully unpacked, please check all parts.



## 3.0 INSTALLATION

When delivered, the Changing Bench will be supplied fully assembled. Always turn hand wheels, levers and screws clockwise to tighten or anti-clockwise to loosen.

### 3.1 Surveying Procedure

- Changing benches/tables are normally installed in small rooms with limited space. In such circumstances it is imperative to take accurate measurements of the whole room in question, and make a plan to scale if possible.
- Ensure that the intended wall for installation is strong enough to support the weight of the changing bench plus the patient.
- If the wall is of brick or concrete construction, it will be strong enough to support the equipment without the need of the backing board.
- If the wall is of hollow or soft insulation block construction, then we would always recommend the backing board is used.
- It is possible to install the bench using wall and floor fixings; care must be taken to survey the junction between wall and floor. If this junction has a large radius fillet, it may be necessary to space the frame off the wall – any such adjustment will impact on the overall installation footprint so must be taken into account when assessing clearances.
- It is possible using the two levelling bolts to provide stability to the frame at the mating surface with the floor in instances where the customer does not wish to make installation holes in the flooring surface itself.
- Check for the position of dado rails, window sills, electrical power points, switches, etc which may affect the installation.
- Check there is sufficient room around other facilities, e.g. wash basins, toilets, etc.
- Remember to take into account the safety rail dimensions – check that the bench would be capable of adjustment over the height range without fouling.
- Check that doors would be clear and that access is still possible.
- Inspect the wall to see if padding/spacing is required to correct wall imperfections.
  
- The Hi-Riser requires a 220-240V AC 50Hz or 110V AC 60Hz power supply.
  
- The power connection must be made in an area that is kept free from moisture or connected via a waterproofed socket with isolation switch.

### 3.2 Installation Tools Required

- Electric hand drill, with appropriate drill bits for wood and masonry
- Set of spanners
- Tape measure
- Spirit level
- Hammer
- Screw driver
- Personal Protection Equipment (PPE); gloves, safety glasses

## 3.3 Installation Procedure

- Carefully unpack the Hi-Riser and lay all parts on to the floor
- Check all components are present and check for damage that may have occurred in transit (see illustration below):

Wall Frame

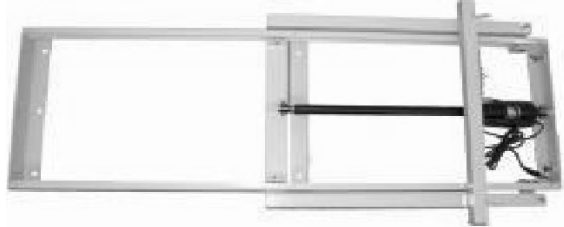

Bench frame with mattress and safety side

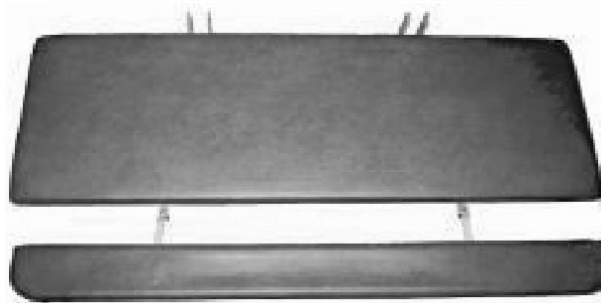

Wall Frame Cover



Handset



Transformer and plug



Fixing screw pack



It is strongly recommended that two people carry out the installation due to the weight of the product.

easyCare  
systems

# INSTALLATION

- Store the wall frame cover and backing board (if ordered) safely until required.
- Offer up the wall frame into the desired position to mark and drill the holes for the fixings; adjust the two leveling bolts as required.
- Where a backing board is to be used, it should be drilled to take fixing screws (minimum 8) – check the screws do not interfere with the wall frame when mounted.
- Fit the fixing bolts and loosely fit the frame to the wall or backing board, being careful not to trap the electrical cable.
- Before tightening fixings, check frame is vertical in all directions, and if necessary fit packing to achieve.
- Before offering up the bench frame to the wall frame, firstly remove the ball end screw that has been loosely fitted to the left-hand hinge.
- The bench frame can now be fixed to the wall frame; the two hinge bolts that are loosely fitted to the wall frame should be removed, and a small amount of Loctite applied to the first 5mm.
- Offer up the bench and insert the two bolts previously prepared but do not over-tighten. The bolts must not protrude more than approx 1mm.
- With the bench frame now in place in the horizontal position, reconnect the ball end screw previously removed and tighten with the appropriate spanner.
- The bench should now be raised into the vertical position and locked in position.
- Locate the lower end of the gas spring (which is fitted to the back of the wall frame) and fit to the ball end on the hinge of the bench frame. This can be snapped into place by pressing the cup firmly onto the ball end. To enable this to be done, it might be necessary to disengage the locking plunger and push the bench frame slightly – remember to re-engage the locking plunger when finished.
- The two side trims may now be fitted using the plastic push fit retainers supplied.
- Check that the gas spring functions correctly and assists in the raising of the bench – make sure it is checked with the safety rail fitted.
- Connect the electrical supply and test the bench by raising and lowering to each of the limits of travel to ensure there are no obstructions.
- Confirm the plunger pin works effectively – you will hear a distinct click when it engages
- The 24V transformer can now be fixed to the wall in a suitable position, or on a bracket/shelf.
- Raise and lower the bench with a load to ensure it is working satisfactorily – do not repeat in rapid succession as this will put stress on the motor system and can cause damage through overheating.
- The main front cover can now be refitted and fixed into place by sliding it down behind the bench so that the Velcro holds the top firmly. Use the studs supplied to fix into place.
- Place a copy of the user instructions on the wall near to the changing bench, where it can easily be read – ensure anyone that will be using the bench is trained and familiar with correct usage.

# INSTALLATION

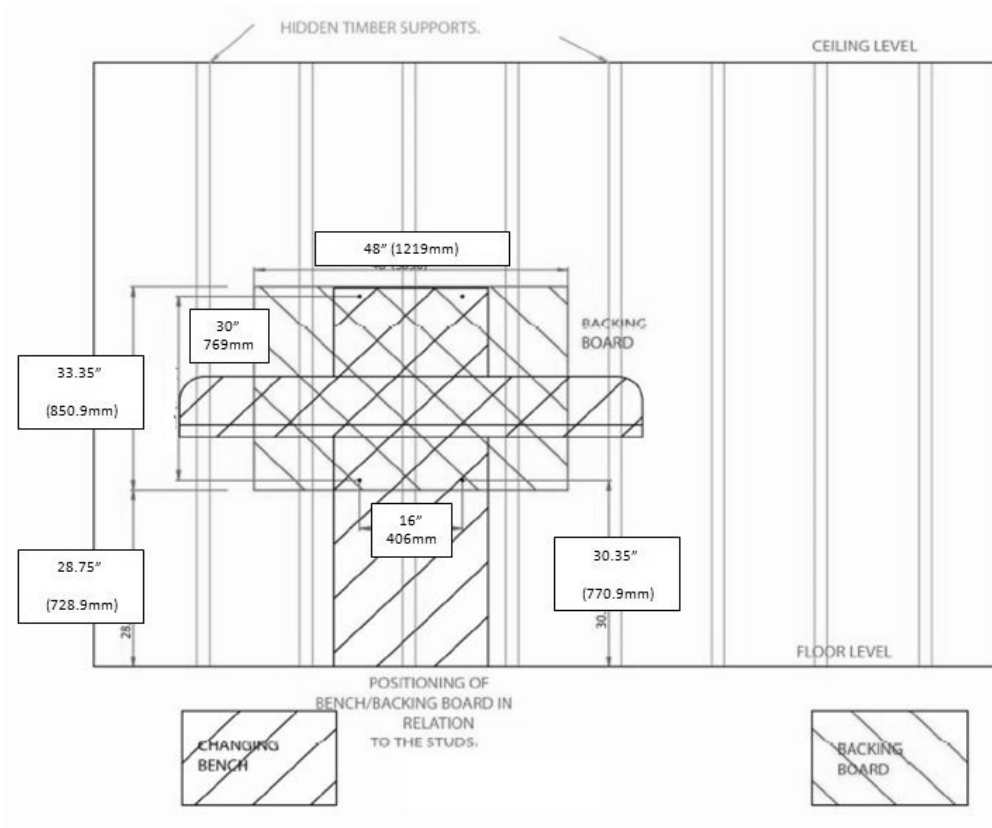
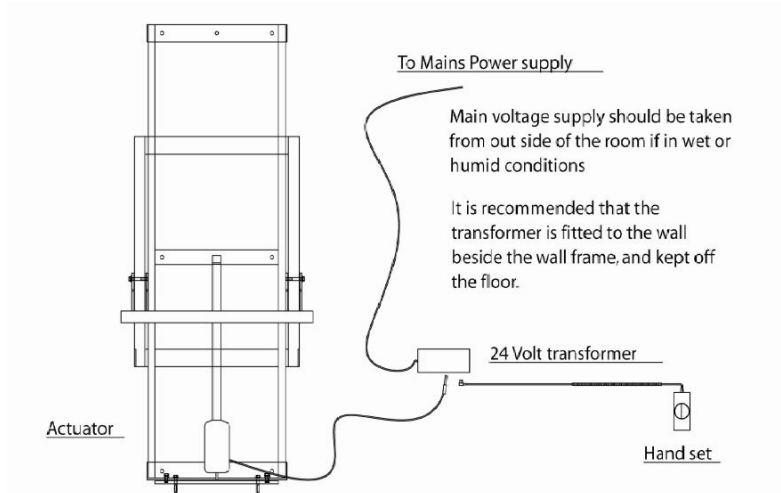

## 3.4 Adjustments



**For non-hoist transfers always ensure the safety side is in the fully stowed position (down). When the user has been transferred onto the Hi-Riser table, please ensure safety side is in the fully upright position.**

- Ensure that the electrical supply to the changing table is ON
- The bed can be lowered from its stowed position by using one hand to gently press the mattress against the frame, and at the same time using your second hand to release the plunger locking pin which is situated by the right hand hinge (shown circled opposite).
- When unlocked, use both hands to lower the bed into the horizontal position.

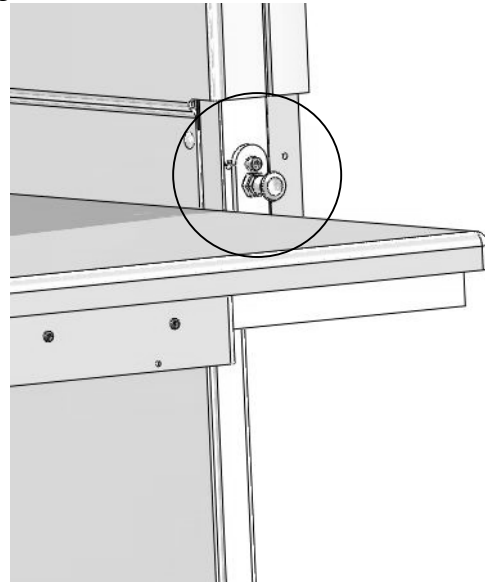

- Before transferring a patient, adjust the height of the bed by using the hand controller 'Up' and 'Down' buttons/arrows, as shown opposite.
- With the patient safely transferred onto the bed, rotate the safety rail into the vertical position and allow it to drop into its retaining slot – check it is in place by gently pulling outwards (towards your body).
- The bench can now be raised to the optimum position, which will depend on the carer

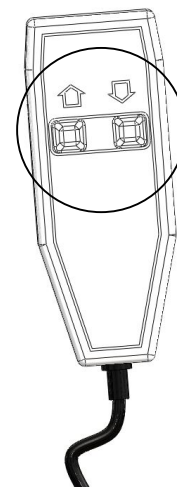

- To dismount the patient, the process is the reverse of the steps described above
- Once the patient has been dismounted, ensure the bed mattress is wiped as per the cleaning instructions (6.0 Cleaning).
- The bench can be stowed away by ing it up with both hands, and when vertical press firmly to slightly compress the mattress – listen for a 'click' which indicates that the plunger locking pin has engaged into the locked position. Confirm this by gently pulling the bed toward you.

N.B. If using a hoist system for patient transfer, the patient can be lowered onto the bed when already set at the desired height, with the safety rail set to the vertical position.

# 4.0 TECHNICAL SPECIFICATION

## 4.1 Changing Bench Dimensions

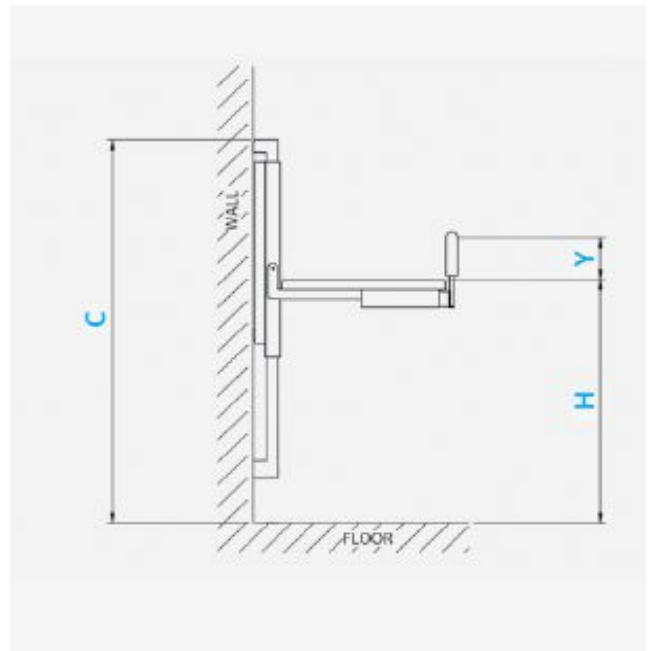
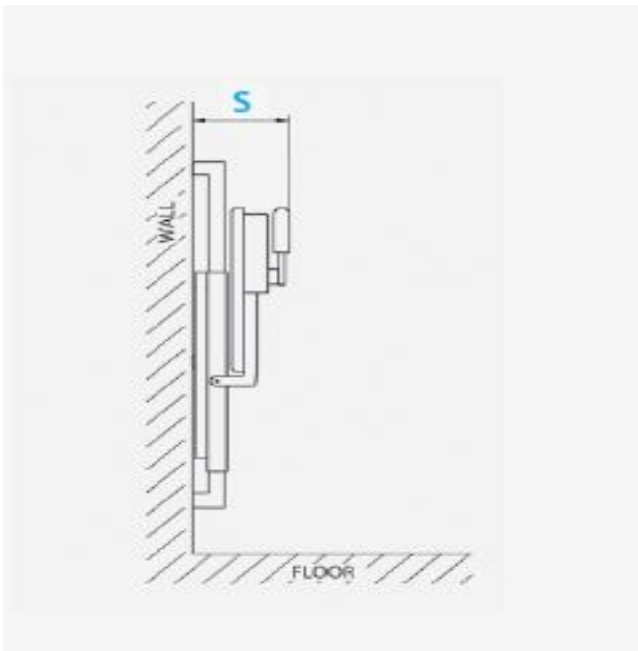
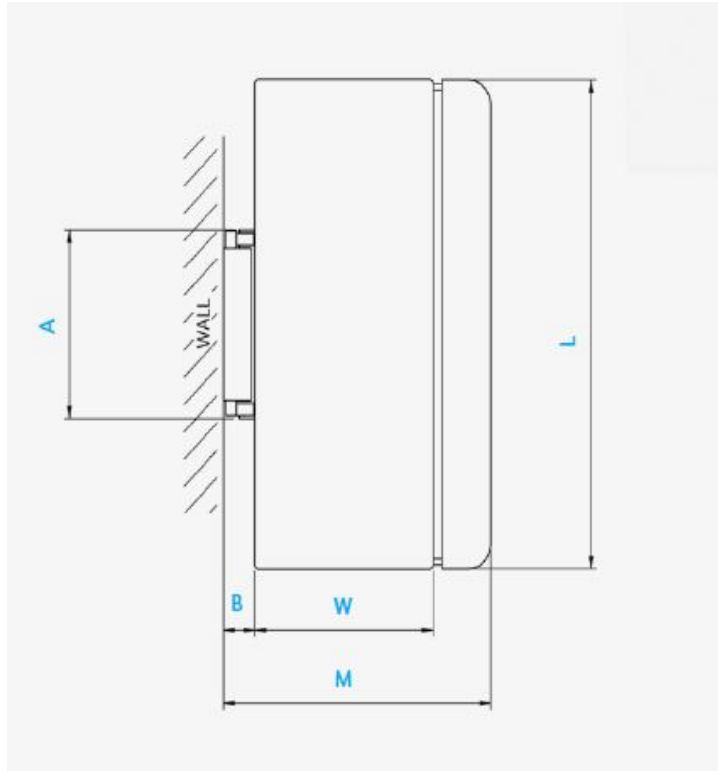

The diagram above shows the relevant dimensional sizes of the Changing Bench. Below (Table 3) is a table containing the dimensions of each size. All dimensions are in mm unless otherwise specified.

# TECHNICAL SPECIFICATION

Measurement		Size 1	Size 2	Size 3	Size 4	Size 5	Size 6	Size 7	Size 8	Size 9
	Product Code (M/S)	3041	3042	3043	3044	3045	3046	3047	3048	3049
	Product Code (S/S)	3051	3052	3053	3054	3055	3056	3057	3058	3059
	Max User Weight (kg)	200								
H	Height Range (mm)*	400 - 1000								
<b>Bed Dimensions</b>										
L	Length (mm)	1200	1300	1400	1500	1600	1700	1800	2000	2100
W	Width (mm)	550		600		650				
M	Width (mm)**	875		925		975				
<b>Safety Sides</b>										
Y	Height (mm)**	165								
<b>Wall Frame</b>										
A	Width (mm)	700								
B	Depth (mm)	110								
C	Height (mm)	1550								
<b>Storage</b>										
S	Width (mm)	305								
	Shipping Weight (kg)	80	82	84	86	88	90	92	94	96

Table 3

\*Dependant on install height  
 \*\*When fitted with stowaway safety rails

## 4.2 Environmental - Storage and Operating Conditions

The Changing Bench is intended for internal use within normal environmental conditions.

It is not intended to be used in environments where there are rapid changes in the environmental temperature and humidity during intended use.

The Hi-Riser Changing Bench suffers little from any effects of lint, dust and light.

- Lint – Due to there being no mechanical or electrical mechanisms on the Hi-Riser Changing Bench, lint would not affect the Changing Bench working.
- Dust – Due to there being no mechanical or electrical mechanisms on the Hi-Riser Changing Bench, dust would not affect the Changing Bench working.
- Light – The Specification of the Changing Bench dictates that normal use would occur during ambient luminance 50 – 500 lux. Additionally, as the Changing Bench is designed for indoor use only, if required the user may wish to switch on room lighting.

## 4.2.1 Normal operating conditions

+5°C to +40°C (41°F to 104°F) at a relative humidity between 15% to 90% RH, non-condensing but not requiring a water vapour pressure greater than 50hPa and atmospheric pressure between 700hPa to 1060hPa

## 4.2.2 Shipping and storage conditions

-25°C to +5°C (-13°F to 41°F) with any humidity level  
+5°C to +35°C (41°F to 95°F) at a relative humidity up to 90%,  
+35°C to 70°C non-condensing at a water vapour pressure up to 50hPa

During all transportation it is recommended that the Changing Bench remains in its original packaging.

It is recommended that the Changing Bench is stored in a cool, dry place out of direct sunlight. If cleaning is required after storage, please see section 6.0 Cleaning of the user manual for instructions.

Shipping and storage conditions are also contained on Hi-Riser Box Label:



[www.easycare systems.co.uk](http://www.easycare systems.co.uk)

## 4.3 Standards Applied

The standards that have been applied to the device are as follows:



- BS EN ISO 12182:2012 (Assistive products for persons with disability. General requirements and test methods).
- IEC 62366:2015 (Application of usability engineering to medical devices).
- BS EN ISO 15233-1 :2016 (Medical devices — Symbols to be used with medical device).

## 4.4 Disposal



Please observe the local laws on recycling and respect the current laws for disposal within the community the device is being used within. If there is any uncertainty of the below guidelines, contact your local authorities to determine the proper method of disposal of potentially bio-hazardous parts and accessories.

## 5.0 GENERAL INSPECTION AND MAINTENANCE



No maintenance is to be carried out on the Changing Bench while in use to reduce the risk of injury.

The user will not require any tools when completing their inspections.

When completing services, the authorised service engineer will provide their own tools, including:

1 x set of metric Allen keys.

### 5.1 Daily Checks - To Be Completed by User

Prior to each use the Hi-Riser Changing Bench must be inspected visually.



Should any of these items fail the inspection, DO NOT use the Changing Bench. Contact your local authorized dealer for service – contact details are on the last page of this manual.

Visually check for the following:

- Check the mattress for signs of damage or wear and tear
- Keep the upholstery and metal parts clean
- Check the safety rail can be stowed and locked into the vertical position
- Check that the bed rises and lowers when activated by the handset
- Check that the bed can be securely stored in the vertical position, and that the plunger locking pin engages.

### 5.2 Service Interval

The Hi-Riser Changing Bench should be serviced every 1 year. Servicing must only be undertaken by a Smirthwaite Ltd. service engineer, or by a Smirthwaite Ltd. trained representative.

### 5.3 Nominal Service Life

Your product has a nominal service life of 7 years, during which full post-sales support will be available with regard to spares and servicing.

Product service life has been determined based upon the design complexity of product, and the anticipated exposure to normal use.

Good practice dictates all Smirthwaite Ltd. products have been designed and manufactured to high levels of safety and quality, and will meet requirements of normal use when maintained in line with our servicing recommendations.



If the product has been out of use for an extended period of time (6 months or more) it should always be serviced prior to being reissued. If the product has been subjected to 'heavy' or 'constant' use, the service should be reduced to half the recommended period.

Constant and/or heavy use is considered to be:

- Daily use above 7 hours' duration.
- Weekly use above 5 days' duration.
- Monthly use above 10 months per year.
- Use by a client who is at 90% to 100% of the maximum weight limit of the product. The maximum weight limit must NEVER be exceeded.
- Use by a client who is extremely active, either voluntarily or involuntarily.

## 5.4 Extending Nominal Service Life

At Smirthwaite Ltd. we are proud to produce products that have a reputation for quality and durability.

We believe our products have the potential to provide benefits to our clients beyond the nominal service life documented above.

We will continue to provide full support beyond the nominal service life provided the following conditions are met:

1. A full service schedule has been maintained.
2. A full service and inspection is undertaken at the end of the nominal service life period.
3. The product is subsequently serviced annually (or biannually if under 'heavy/constant' use conditions).
4. Smirthwaite Ltd. reserve the right to limit support where parts/components are no longer available.

## 5.5 User Serviceable Parts

Please contact Smirthwaite Ltd. or your local dealer for information to assist service requirements on the Hi-Riser – e.g. to ascertain the necessary information for replacement parts and components. Contact details are shown on the last page of this manual

## 5.6 Final Inspection

When the service is complete:

- Remove any waste created as part of the service from the site.
- Confirm with the operator if the Changing Bench is safe to use and that it has been left in a working state. Isolate the Changing Bench if it is not safe to operate.
- Complete all documentation – see section '7.0 Service Documentation.'



Incorrect use may result in personal injury or damage to objects

## 6.0 CLEANING

Please follow the cleaning guidelines below; noting the frequency is appropriate with usage.



It is recommended to clean the Hi-Riser Changing Bench and accessories before use by a different person, reducing the risk of cross-contamination.

### 6.1 General cleaning

The exterior of the Hi-Riser Changing Bench can be cleaned using a damp soapy cloth for general cleaning duties. Please ensure the cloth is damp and not wet. Ensure the exterior of the Changing Bench is dry after cleaning. Dry using a clean dry cloth.

- Upholstery - damp cloth and mild detergent.
- Wooden Parts - damp cloth and mild detergent.

Key cleaning points include;

- Stubborn marks on the woodwork should be cleaned by using a soft brush.
- Do not soak or immerse the Changing Bench in water.
- The pelvic strap can be cleaned with a damp cloth. In cases of extreme soiling it can be machined washed at low temperature with mild detergent but must be drip dried.
- Store the Changing Bench in a cool dry place out of direct sunlight.



DO NOT use bleach, solvents, abrasives, synthetic detergents, wax polishes, antibacterial sprays or wipes.

For further information, please refer to MHRA or your NHS cleaning guidelines.

## 7.0 SERVICE DOCUMENTATION

### 7.1 Documentation/ Records

It is the responsibility of the current equipment owner to ensure the Service Manual (As well as any further manuals for accessories fitted to the equipment) are handed over to the new owner at the time of exchange/sale.

It is the responsibility of the current equipment owner to ensure the service and inspection record form is kept up to date.





[www.easycare systems.co.uk](http://www.easycare systems.co.uk)

**Contact Us**

Units 5 and 6 Lower Vicarage Road  
Southampton  
Hampshire  
SO19 7RJ  
T: 02380 420678  
E: [info@easycare systems.co.uk](mailto:info@easycare systems.co.uk)