

[www.easycare systems.co.uk](http://www.easycare systems.co.uk)



## Contents

User manual - English - 4

## General

### CE declaration



The product, and its related accessories, described in this instruction for use (IFU), is in compliance with the regulation (EU) 2017/745 of 5. April 2017 – as a medical device, risk class I. The product is manufactured and tested according to EN 12182:2012 and selected parts of EN/ISO 10535:2006. Any serious incident that occurs in relation to the device should be reported to the manufacturer and the competent authority of the Member State in which the user and/or patient is established.

### Conditions for Use:

Transferring a person may pose an element of risk. Only trained personnel should use the equipment covered by this user manual.

### Warranty notice

Two-year warranty against defects in workmanship and materials of our products.

Please refer to [www.etac.com](http://www.etac.com) for terms and conditions.

Visit [www.etac.com](http://www.etac.com) to download the latest version of our documentation.

## Important

This User Manual contains important safety instructions and information regarding the use of the Turner PRO and accessories. In this manual the user is the person being transferred. The assistant is the person operating the Turner PRO.



This symbol indicates important information related to safety. Follow these instructions carefully.



### Read User Manual before use!

It is important to fully understand the content of the user manual before attempting to use the equipment.

### Modifications and use of components made by other manufacturers:

We recommend only using Etac components and spare parts. Declaration of conformity is not valid and Etac is not responsible for warranty if any modifications are made to the product. Etac shall not be liable for faults or accidents that can occur when using components made by other manufacturers.

## Risk assessment

Assess the risk and take notes.

You as the assistant are responsible for the safety of the user!



Only technical personnel are allowed to perform repairs.

## Labels and symbols

### Product label:

The label contains art. number and serial number (bar codes). The EAN code contains;

(01) (EAN no.): xxxxxxxxxxxxxx

(11) (Batch): YYMMDD

(21) (Serial number): xxxxx



### Symbols:

Symbols used on the product, explained in more detail:



Manufacturer



Date of manufacture



Catalogue number



Serial number



Medical Device



CE marked



Refer to user manual



Max temperature when washing



Max user weight (SWL)



pH when washing



QR code

### Short user guide:

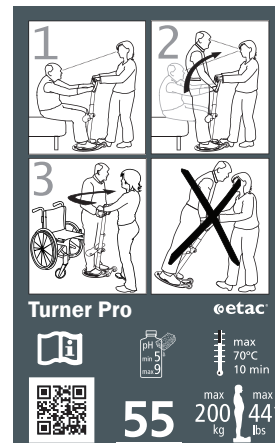

## Turner PRO - intended use

Turner Pro is a sit-to-stand transfer aid that makes it easier for a carer to help a user to stand and transfer him/her to another sitting position. Users must be able to grip and pull up their own body weight, but still require support/help to stand up and be turned. The purpose is to transfer a person from/to bed, chair, wheelchair or toilet. The Turner PRO is lightweight and easy to move around. The Turner PRO should only be used indoor on flat surfaces.

## Turner PRO

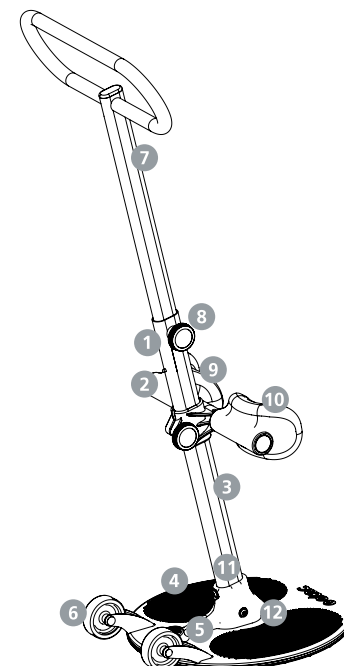

1. Outer pole
2. Lock pin
3. Height label
4. Main plate
5. Assistant footrest
6. Transport wheels
7. Inner pole with handle
8. Turning knob
9. Short user guide
10. Leg support
11. Product label
12. Bolts

Technical data

Safe Working Load (SWL):

200 kg (441 lbs)

Weight of unit:

8kg

Dimensions:

- Height (A): 0,8-1,2 m
- Height (B): 0,3-0,55 m
- Depth (C): 0,46 m
- Width (D): 0,45 m
- Footplate (Ø): 0,40 m

Material:

Powder coated aluminum, Plastic, Steel.

Expected Lifetime:

The Turner PRO has an expected lifetime of 5 years or 15000 turning cycles

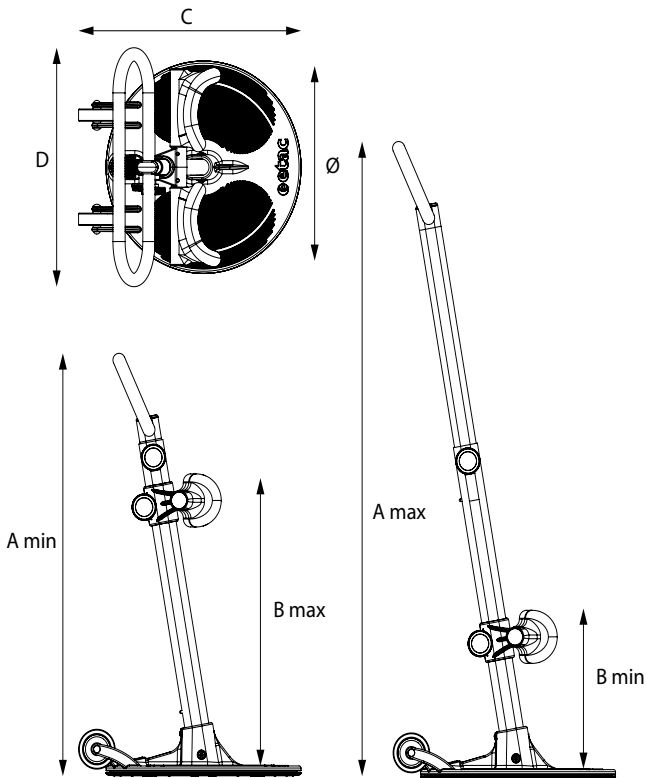

Mounting leg support

The knee cushions are adjusted individually. The leg support has step-less adjustment from 0,3 to 0,55 meters. Follow these two steps when mounting the leg support:

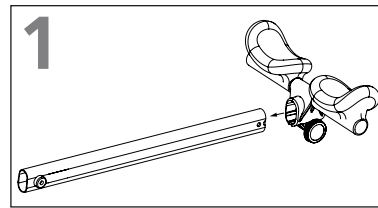

1 Lay the pole down on an even surface. Insert leg support with kneepads pointing upwards. Make sure both knobs are on the same side.

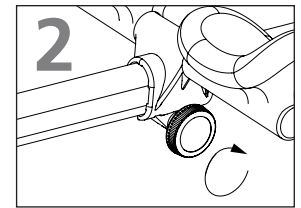

2 Tighten knob by turning knob clockwise.

Mounting pole to main plate

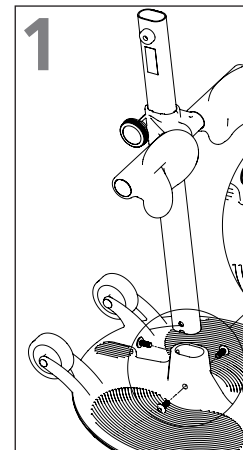

1 Place the base plate on an even surface. Insert pole with knee pads facing away from the wheels.

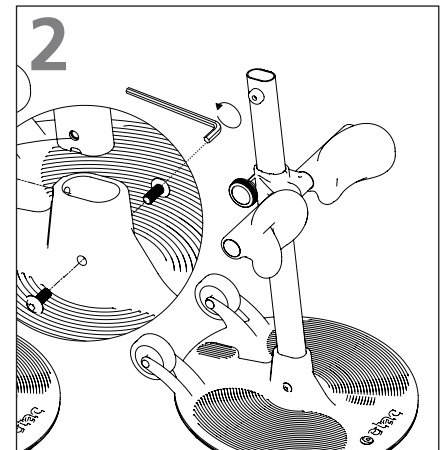

2 Insert all three screws into holes in the base plate. Use allen key to screw in bolts. Tighten bolts firmly.



**Make sure that all three bolts are properly fastened. Loose bolts can make the pole wobbly and the Turner PRO unsafe to use.**

Supplied parts

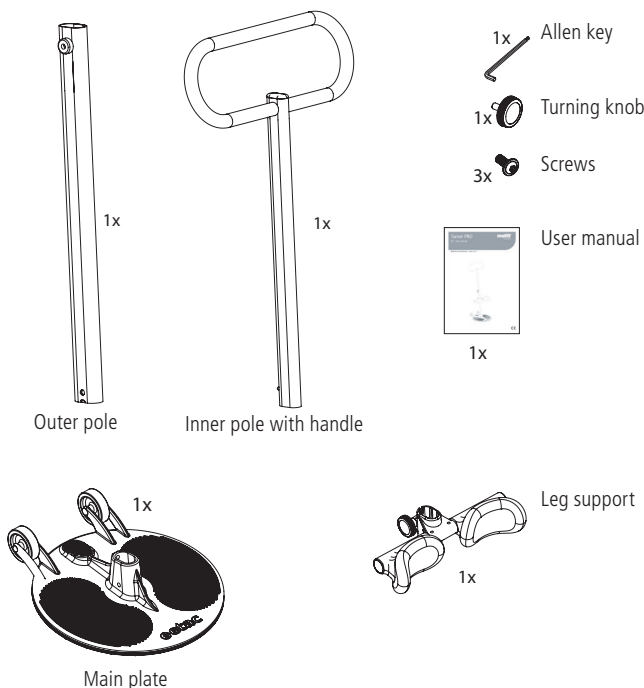

Mounting handle

The handle has step-less adjustment from 0,8 to 1,2 meters. Follow these three steps when mounting the handle:

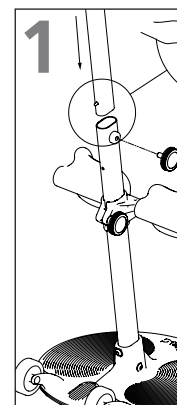

1 Place the handle with the lock-pin pointing towards the wheels.

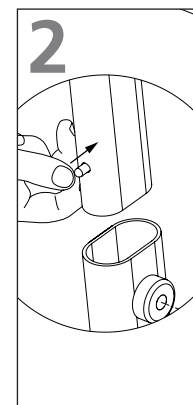

2 Press in the lock pin and slide the pole into the mounted pole.

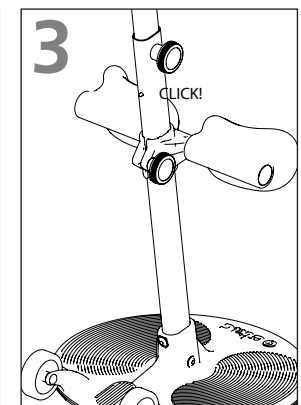

3 There will be a clicking sound when it is correctly mounted. Turn and tighten the knob.

Checklist after assembly



Don't start using Turner PRO before completing the checklist after assembly.

Use this checklist to verify that the Turner PRO is properly installed and can operate correctly and safely before use. See assembly information on the previous page for details.

- Make sure that the leg support is mounted correctly.
- Make sure that all three bolts between outer pole and main plate are mounted correctly and properly tightened.
- Make sure that the handle (inner pole) is mounted correctly.
- Make sure Turner rotates freely.

Adjusting handle height

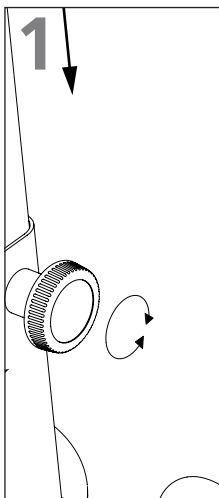

1 Turn knob counter clockwise and adjust handle height.

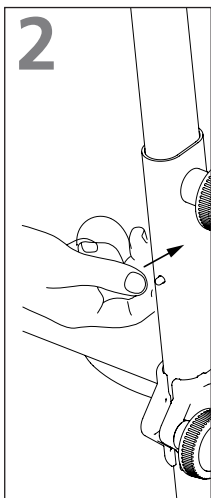

2 Push the lock pin in if the handle is in upper position.

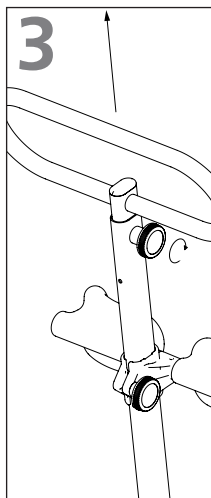

3 When correct handle height is obtained, turn knob clockwise to lock the position.



Be aware of handle when adjusting height. Handle can slide down and hit operators head or upper body.



Don't use handle in a position above the lock pin position. This makes the pole wobbly and the Turner unsafe to use.

Adjusting leg support height

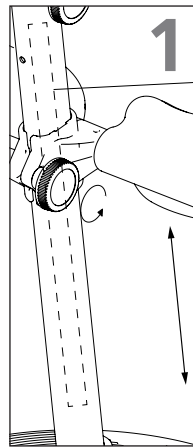

1 Turn knob anti clockwise and adjust knee support height.

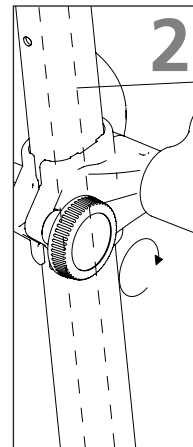

2 When correct knee support height is obtained, turn knob clockwise to lock the position.

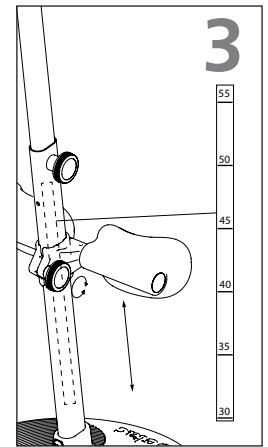

3 The knee support height can be read from the scale on the pole. The number above the leg support bracket refers to the correct height.



Make sure knobs are securely tightened. Loose knobs can cause handle or knee support to slide down and make the Turner unsafe to use.

Positioning Turner PRO



1 Position the new seat (chair, wheelchair, toilet or bed) in an 90 degree angle with the existing seat.

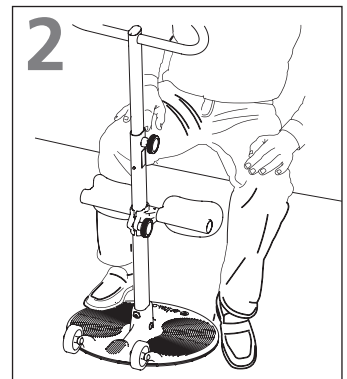

2 Slide the Turner PRO in under the users feet.

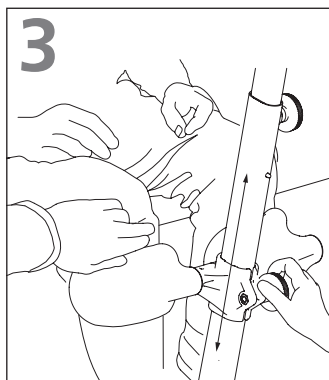

3 Adjust the height of the leg support so it is positioned two fingers beneath the users knee cap.

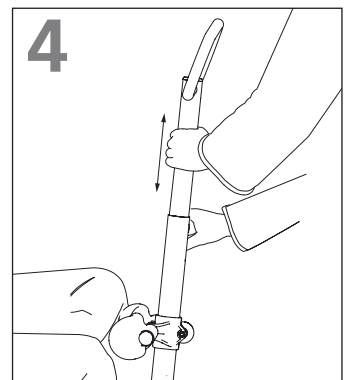

4 Adjust the height of the handle to a position that is comfortable for both user and assistant.

Transport and storage

Turner PRO can be stored and transported under temperatures between -25 - 70 °C and relative humidity between 15 - 93 %

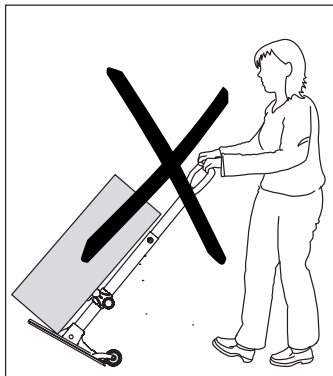

 Don't use the Turner Pro for transportation of people or goods.

Transferring user

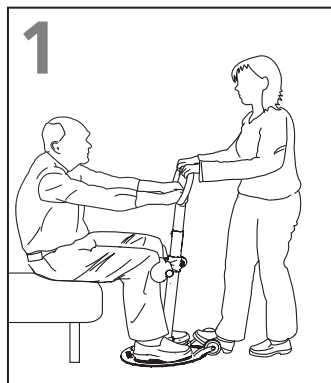

1  
Grip the handle with both hands and place one foot on the foot rest. The user grips the handle, if possible with both hands.

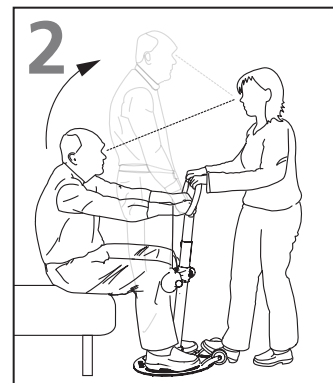

2  
Encourage the user to stand up, at the same time, counter-balancing the users weight using a foot and hands (use your bodyweight by leaning backwards).

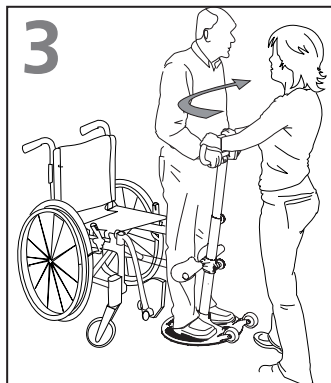



3  
Twist the Turner PRO so that the user is transferred to the front of the new seat.



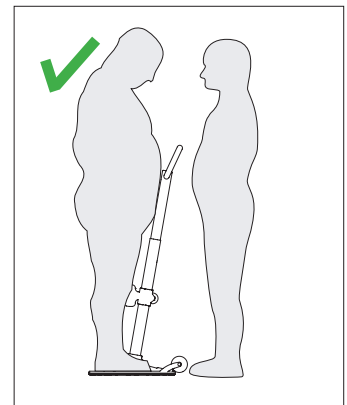
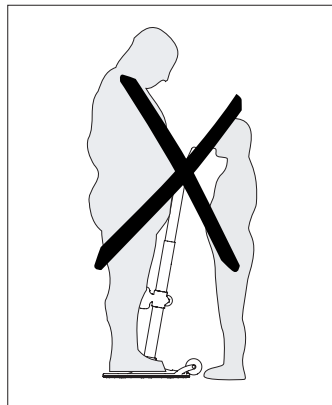

4  
Step on footrest, brace your weight and ask the user to sit down. Maintain eye contact with the user during the entire transfer process.

User / Assistant

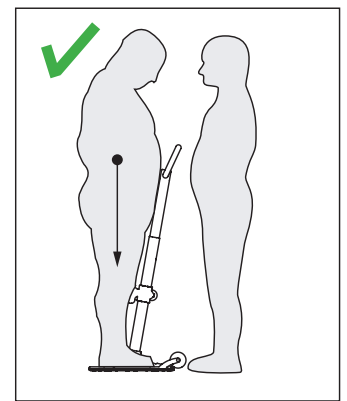
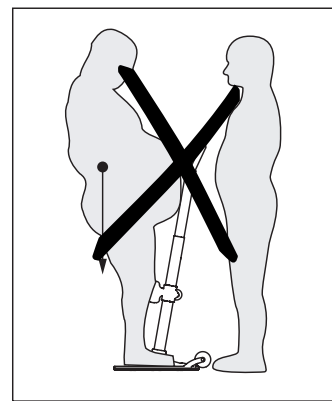

 The assistant has to be able to handle the weight of the user.



 Make sure the users weight is within the baseplate.

Cleaning and disinfection

Clean on a regular basis. Clean surfaces with a damp cloth using an appropriate pH-neutral detergent. Do not use solvents or strong liquids, this may damage surfaces on the Turner. For disinfection when needed; use isopropyl alcohol or similar. Avoid abrasive cleaning products. Remove hair and pile from the wheels and verify that the wheels rotates freely.

 Make sure not to damage or remove labels when cleaning.

Reconditioning

Follow cleaning and assembly procedure. Separate reconditioning document is available at Etac.com.

Recycling

Turner PRO can be disposed of as metal waste. Recycling instructions is available at Etac.com

Spare parts

A list of spare parts is available at Etac.com.



## Special Products and Service

### **Contact Us**

Units 5 and 6 Lower Vicarage Road Southampton

Hampshire

SO19 7RJ

T: 02380 420678

E: [info@easycare systems.co.uk](mailto:info@easycare systems.co.uk)

[www.easycare systems.co.uk](http://www.easycare systems.co.uk)