

MANGAR

ELK LIFTING CUSHION

USER INSTRUCTIONS



Table of Contents

Warnings 3

Intended Use 3

Standard Product Contents 3

Positioning the ELK 4

Transferring the patient onto the ELK 5

Connecting the 4-way Hand Control and Airflo 24 6

Operating 7

Routine Cleaning 8

Disinfecting 8

Maintenance 8

Transportation/Storage 8

Disposal/Recycling 8

Troubleshooting 9

Specifications 9

Warranty 10

Declaration of Conformity 11



Ensure that you read and understand this instruction manual before using this product. Failure to follow the instructions and safety precautions in this manual can result in damage and/or serious injury.



Please keep these instructions in a safe location for future reference

WARNINGS

- This equipment must only be used by persons practiced in its use.
- To maintain stability, persons being lifted must have the assistance of one or more competent assistants.
- The medical state of a person needing to be raised MUST be assessed before commencing a lift.
- Users should assess what assistance may be required before commencing a lift.
- Ensure that the surface on which the ELK is to be placed, is free from sharp objects.
NOTE: Place a blanket, groundsheet, towel or similar under the ELK if using it on a rough surface.
- While in use, never allow a section to become partially deflated while any sections above it are inflated. Sections must always be fully inflated from the bottom up, in sequence, in order to maintain stability.
- Do not operate the Airflo 24 compressor in the presence of flammable anaesthetic mixtures with air, oxygen or nitrous oxide, as these mixtures can create a combustible environment leading to the potential for fire or even an explosion in the presence of a spark.

Intended Use

The Mangar Elk is a four section emergency lifting cushion, which when operated by a person experienced in its use, is designed to lift a patient from the floor to an elevated sitting position. Once in a sitting position, the patient can be transferred to a chair or helped to a standing position. The ELK is powered by a Mangar battery powered Airflo 24 compressor and controlled using a Mangar 4-Way Hand Control.

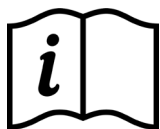

PLEASE REFER TO THE SEPARATE AIRFLO 24 COMPRESSOR INSTRUCTIONS BEFORE OPERATING.

Standard Product Contents

- 1 x ELK (A)
- 1 x 4-Way Hand Control (B)
- 1 x User Instructions (C)

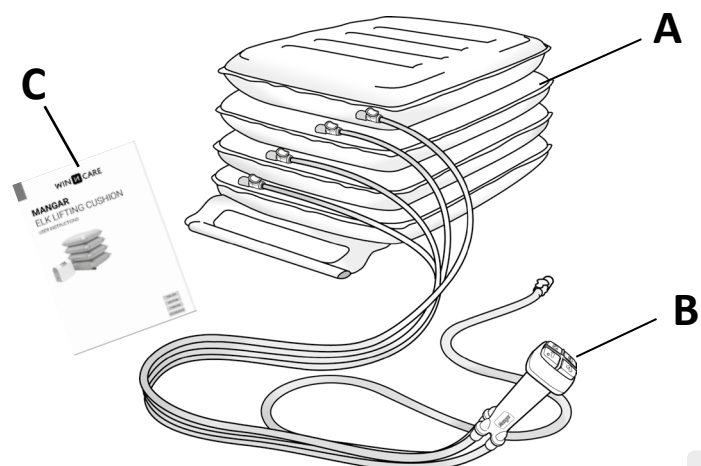

ELK

ENGLISH

Positioning the ELK

- Place the patient in the recovery position if they are unable to transfer themselves onto the ELK.
- Unroll the ELK by unclipping the flap (**A** fig.1) from the ends of the stability bar (**B**).

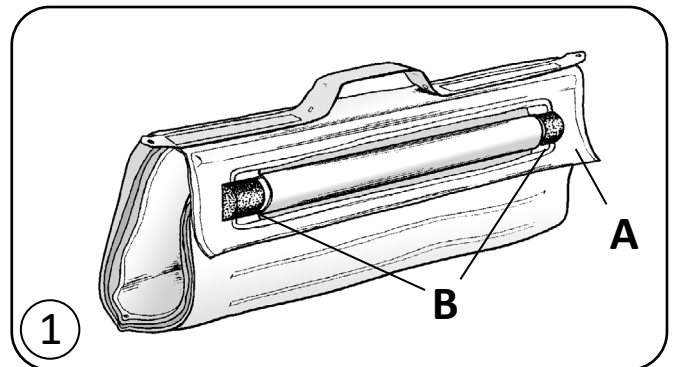

- Remove the end cap and then the stability bar from its pocket (**B** fig. 2) in order to provide a more comfortable transfer for the patient.

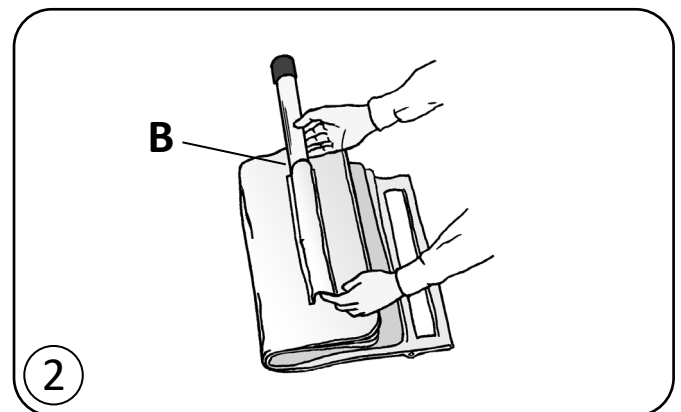

- Fold the edge of the ELK underneath itself, by folding along the line of the stability bar pocket (fig. 3).

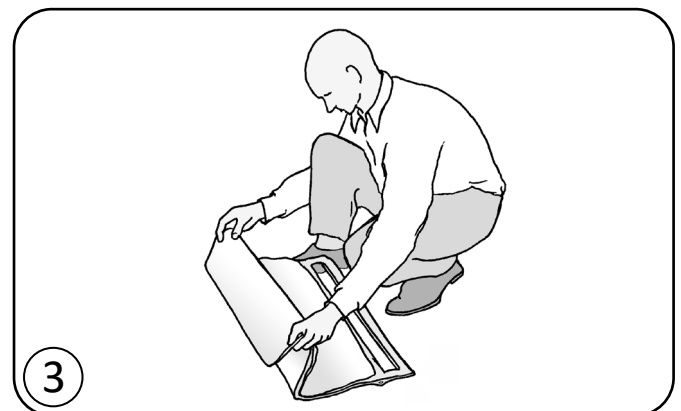

- Position the ELK so that its 'upper' edge is approximately level with and tight up against the patient's waistband (fig.4). **NOTE:** Place a blanket, groundsheet, towel or similar under the ELK if using it on a rough surface.

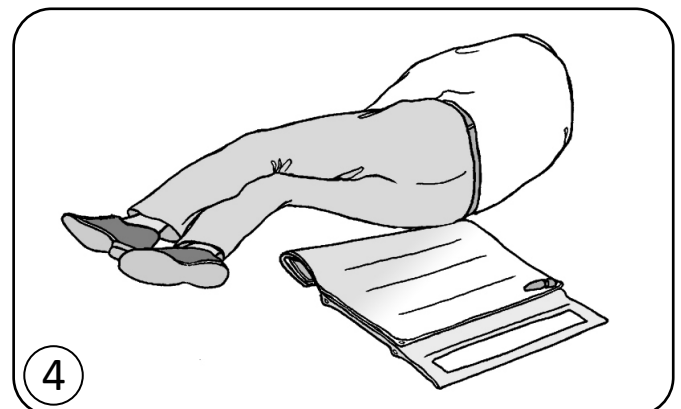

NOTE: If the fallen person is very large, it is recommended to connect the Airflo 24 compressor and the hand control before the person is rolled onto the Elk.

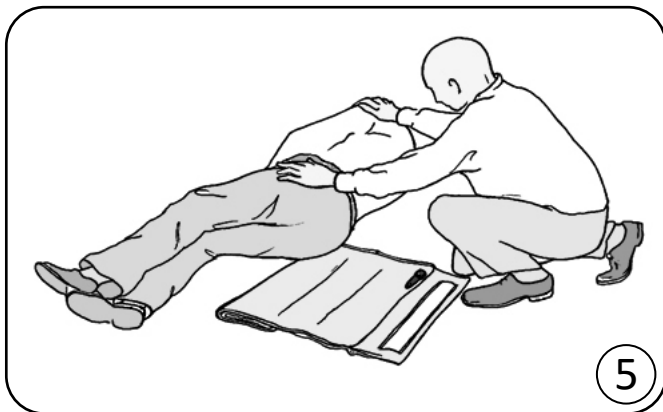

Transferring the patient onto the ELK

- Roll the patient over onto the ELK (fig. 5).

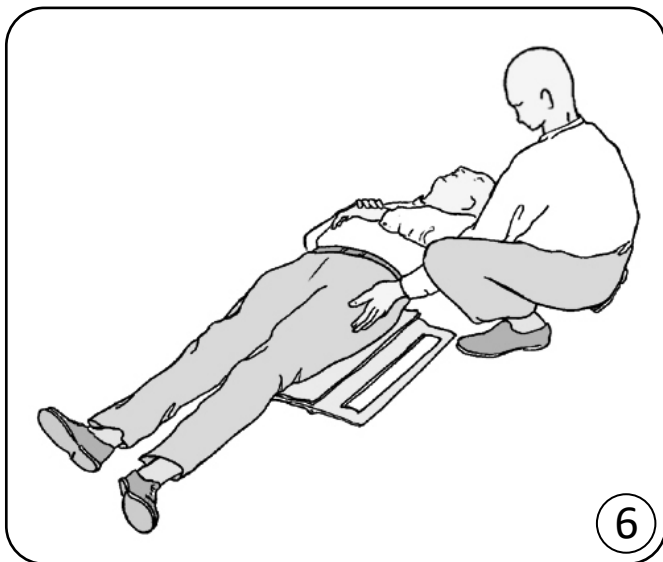

- Carry on rolling until the patient is lying fully and squarely on the ELK (fig. 6).

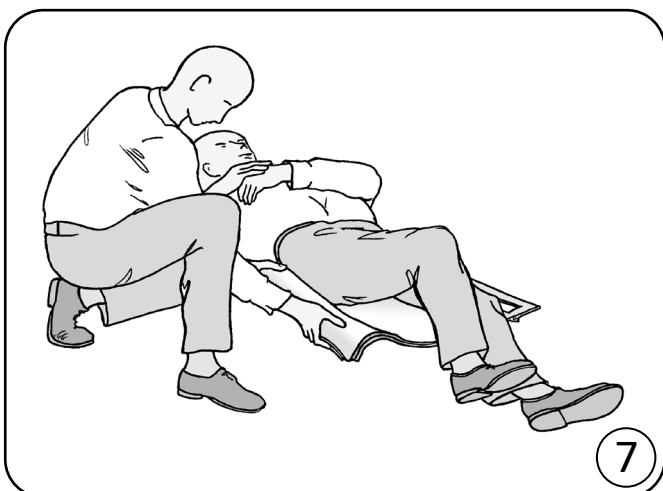

- Unfold the folded over edge of the ELK (fig.7).

- Replace the stability bar and refit the end cap (fig. 8).

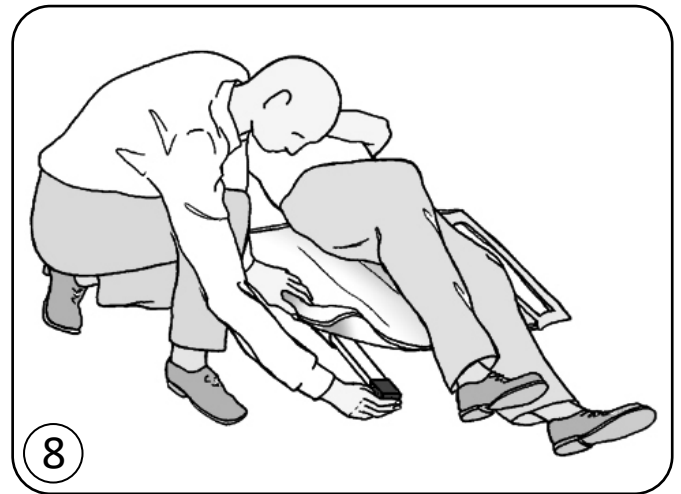

Connecting the 4-Way Hand Control and Airflo 24

- Connect the four distribution hoses (**A** fig.9) from the 4-Way Hand Control to the four connectors on the ELK (fig.9 inset). The ends of the hoses are colour coded and numbered to match the corresponding ELK connectors (No. 4 is the top section; No.1 the bottom).
- Position the Airflo 24 compressor at the side of the ELK ensuring that it will not be in the way while lifting and supporting the patient.
- Connect the hose from the 4-Way Hand Control to the air outlet socket on the Airflo 24 compressor (**B** fig. 9) and press the 'Power' button (**C** fig. 9). The bottom green light on the battery status indicator will come on to indicate that the Airflo is switched 'On' and ready to use (see separate - Airflo 24 user instructions).

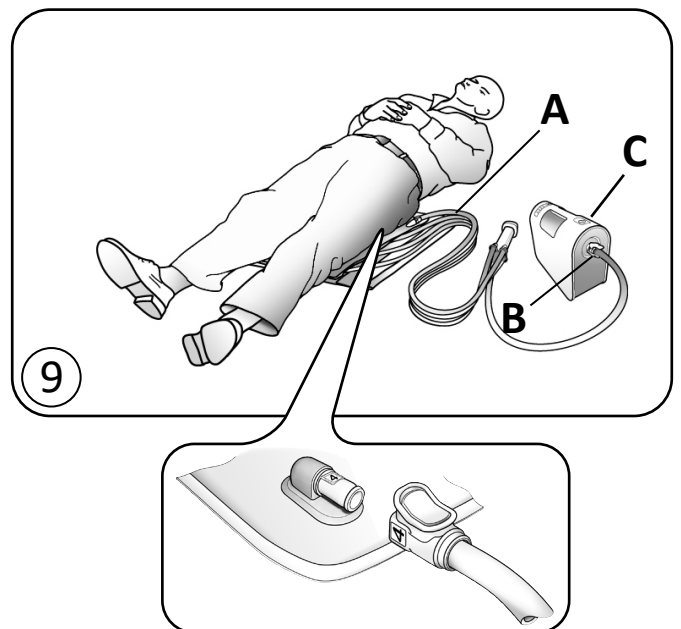

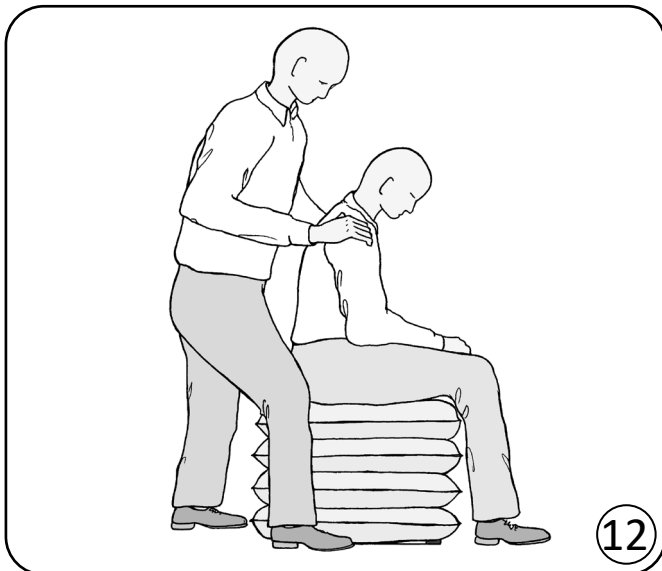
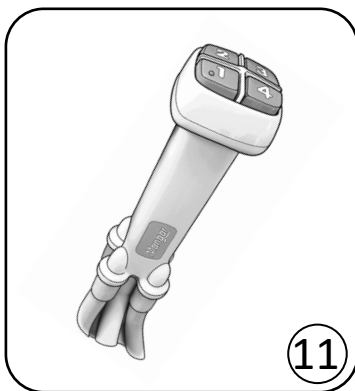
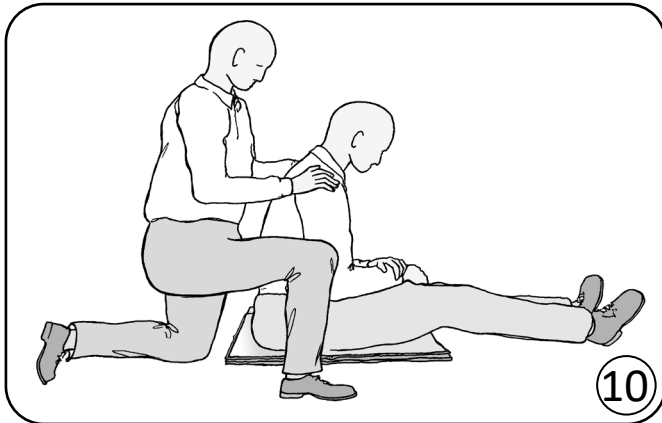

Operating

- Having positioned the ELK under the patient and connected it to the 4-Way Hand Control and Airflo 24 compressor, if possible, position a sturdy chair next to the patient for them to hold so as to provide additional stability.
- Kneeling beside the patient, place them in a seated position on the ELK (fig.10). When in the seated position, the patient should place their arm on the chair seat to provide further stability. If necessary, place a transfer belt (with looped handles) around the patient's chest and adjust to fit). Use the handles on this belt to provide additional support and stability while elevating.
- Explain to the patient what to expect when the ELK elevates.
- Switch the Airflo 24 to 'On'. Press the number 1 button on the 4-Way Hand Control (fig.11). Steady the patient as the ELK lifts. The compressor will automatically stop as the section becomes fully inflated.
- Continue to operate buttons 2, 3 and 4, in sequence, in exactly the same manner. Support the patient at all times. Always inflate the ELK sections from the BOTTOM UP BEGINNING WITH THE NO. 1 BUTTON.
- When all four sections are inflated, the patient may be helped to stand or to transfer (fig. 12).
- To deflate the ELK, first disconnect the air hose from the Airflo 24 and then press each of the buttons on the hand control in turn to reduce the pressure in each section. Once pressure has been reduced, disconnect each of the air hoses from the ELK.
- After use, roll the ELK up with the 4-Way Hand Control and re-secure the flap around the ends of the stability bar (see fig. 1).

WARNING: While in use, never allow a section to become partially deflated while any sections above it are inflated. Sections must always be fully inflated from the bottom up, in sequence, in order to maintain stability.

Routine Cleaning

Fully inflate all sections of the ELK, sponge clean with a non abrasive proprietary liquid cleaner or disinfectant and rinse thoroughly with clean water to remove all soap deposits. Dry thoroughly by wiping or leave to air dry. **Do not dry using hot air.**

Disinfecting

The ELK should be fully inflated and pre-cleaned by washing with detergent and water, thoroughly rinsed and then disinfected using a 1:10 solution of household liquid bleach and water (1 part bleach to 10 parts cold water). Leave the solution on the ELK for approximately 10 minutes before thoroughly rinsing off with clean cold water. Allow to air dry before storage. **Do not dry using hot air.**

Maintenance

Other than routine cleaning and disinfecting, the ELK is maintenance free.

WinnCare recommends that your Elk is inspected annually by either your supplier or other suitably qualified person. If required, WinnCare can provide the above inspection within an annual service contract (UK only). Please contact our Customer Service Department for further details on Freephone 0800 2800 485.

Transportation / Storage

Disconnect the Airflo 24 compressor from the ELK before transporting so as to avoid accidental inflation of the cushion.

Ensure that the ELK is clean and thoroughly dry before storing. Failure to thoroughly dry the cushion before storage may result in a build-up of mould on the surface of the product leading to a weakening of the fabric and consequential invalidation of the product warranty. Store in a dry environment.

To maintain the Airflo 24 battery when being stored for long periods, put on charge for 12 hours every 3 months.

Disposal / Recycling

When the ELK has reached the end of its working life, dispose of it at your local recycling centre (civic amenity site).

When the Airflo 24 has reached the end of its working life, remove the battery for safe disposal in accordance with your local council guidelines, and dispose of the Airflo 24 at your local recycling centre (civic amenity site).

Trouble shooting guide	
Problem	Remedy
<ul style="list-style-type: none"> Compressor does not run when the 4 way hand control buttons are pressed. 	<ul style="list-style-type: none"> Ensure that the Airflo 24 has been switched on. Ensure the charger is disconnected from the Airflo Check that there are no kinks in the air hose.
<ul style="list-style-type: none"> Compressor keeps stopping when trying to inflate the lifting aid. 	<ul style="list-style-type: none"> Check that there are no kinks in the air hose.
<ul style="list-style-type: none"> No Battery status indicator Lights 	<ul style="list-style-type: none"> Unit switched off-turn unit on. Thermal fuse on battery has tripped – Allow unit to cool down 60-90minutes. A solid red LED will display after temperature normalizes and fuse resets. This will have reset the charge sequence. To avoid damage to the Airflo after 12hour charge, disconnect from charger and allow another 60-90minutes for battery cool down.
<ul style="list-style-type: none"> Bottom Battery status indicator solid Red Light 	<ul style="list-style-type: none"> Low Battery Capacity, recharge.
<ul style="list-style-type: none"> Bottom Battery status indicator Flashing Red every 2 seconds 	<ul style="list-style-type: none"> Internal Pump Temperature too high – allow Airflo to cool down 60-90mins before attempting a lift.
<ul style="list-style-type: none"> Bottom Battery status indicator flashing Red every ½ second 	<ul style="list-style-type: none"> Battery Voltage low – Re charge. If occurs repeatedly replace the battery.
<ul style="list-style-type: none"> Compressor causes electrical interference with another piece of electrical equipment. 	<ul style="list-style-type: none"> Move either the compressor or other item further away from each other until the interference stops.

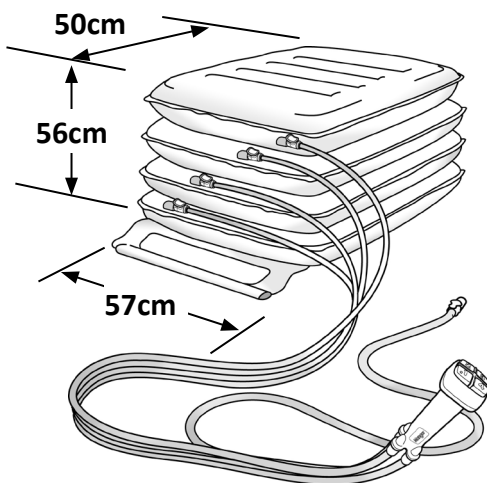

Specifications

- Maximum load: 450kg (992lbs)
- Weight of ELK: 3.6kg (8lbs)
- Dimensions: 57cm (W) x 50cm (D) x 56cm (H)
(22½" W x 19¾" D x 22" H)
- Max. air pressure: 0.35 bar (5psi)
- Max/Min temperature: +50°C / -15°C
(122°F / 5°F)

ELK

ENGLISH



Special Products and Service

Contact Us

Units 5 and 6 Lower Vicarage Road Southampton
Hampshire
SO19 7RJ
T: 02380 420678
E: info@easycare systems.co.uk