

Etac Swift Mobil-2

Manual

etac®

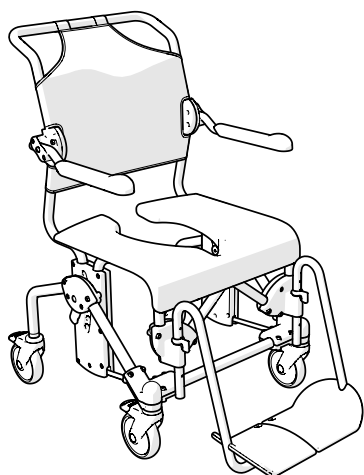

Swift Mobil-2

Swift Mobil-2 XL

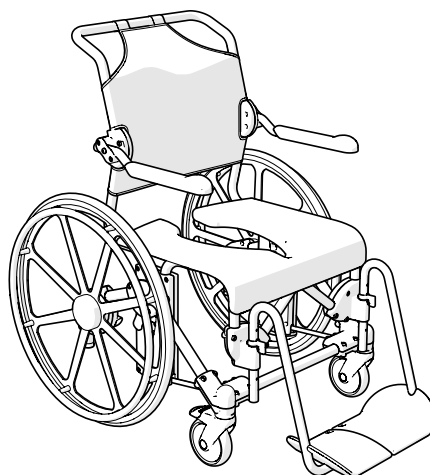

Swift Mobil 24"-2

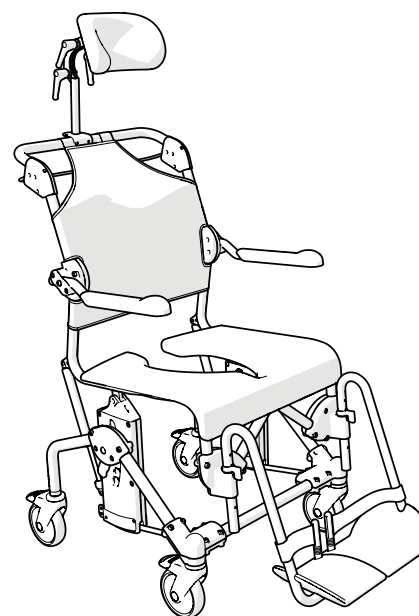

Swift Mobil Tilt-2

Swift Mobil Tilt-2 XL

easy&care
systems



Special Products and Service

A

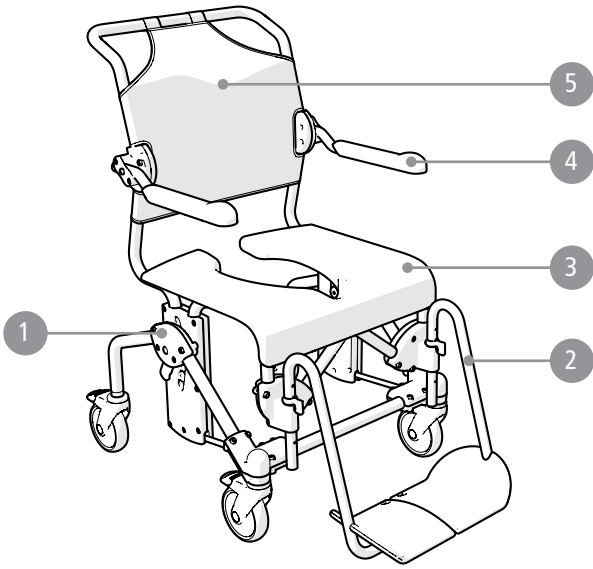

Swift Mobil-2

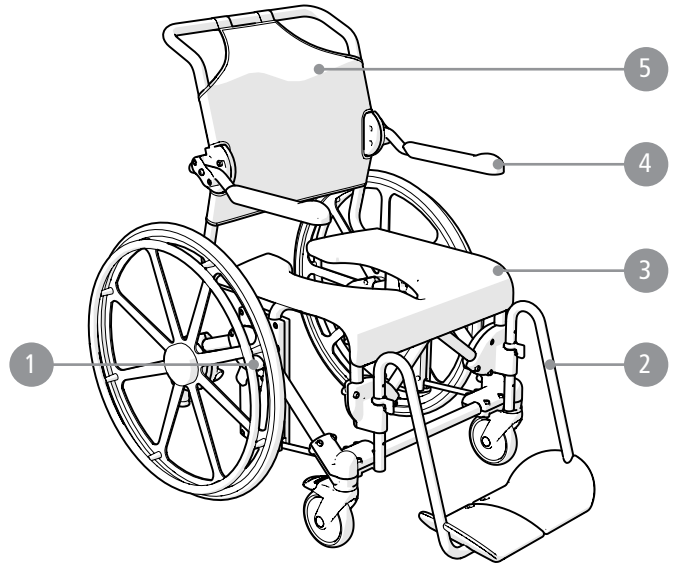

Swift Mobil 24''-2

Swift Mobil-2 XL

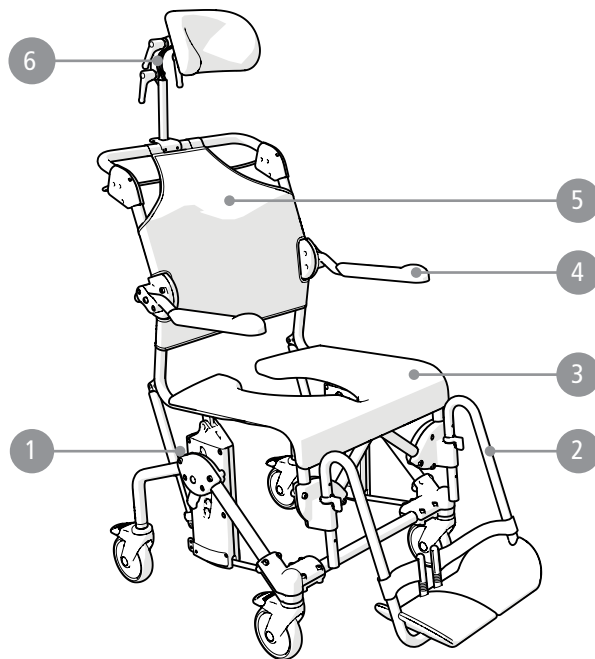





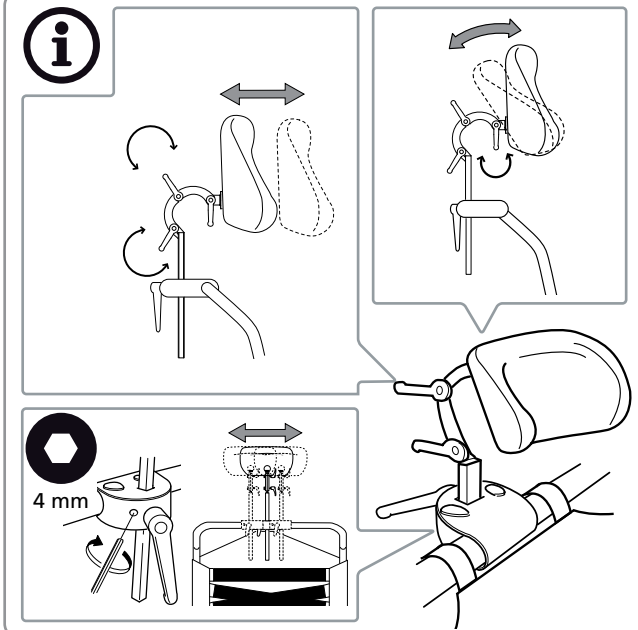
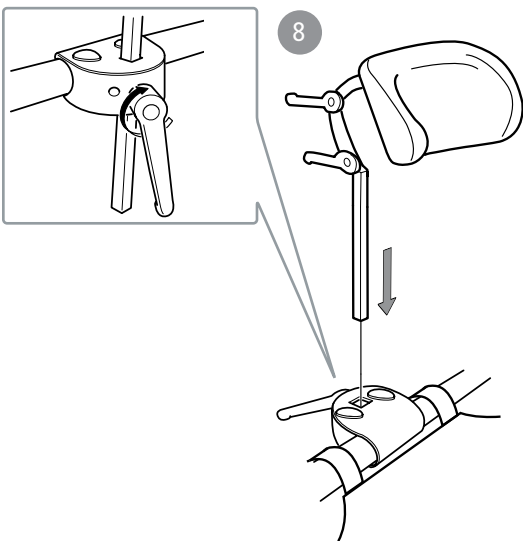
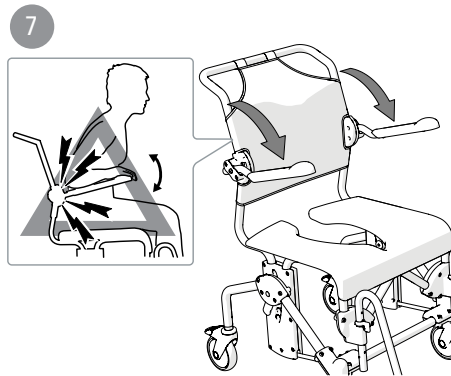
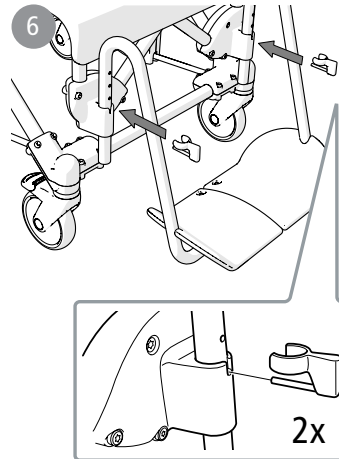
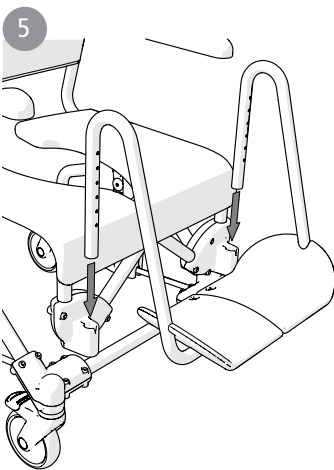
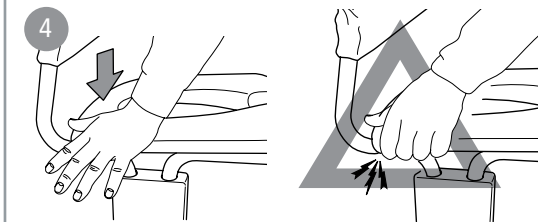
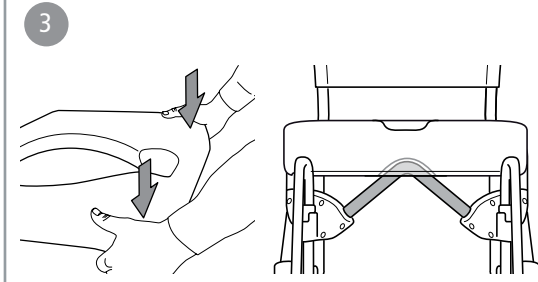
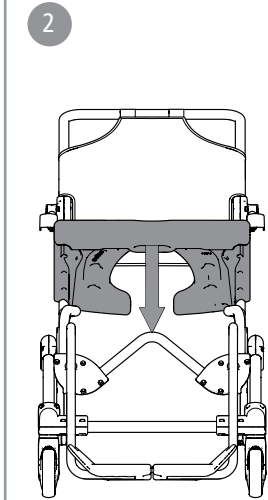
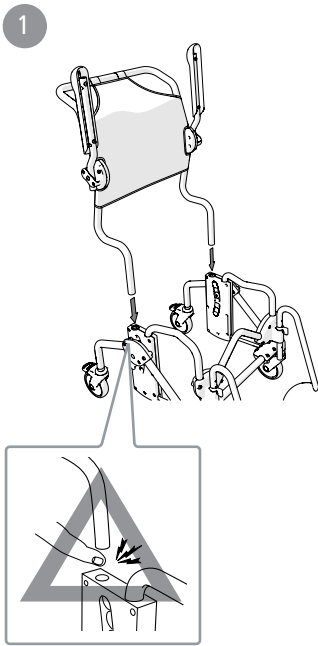

Swift Mobil Tilt-2



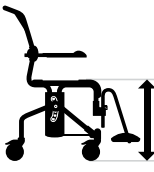
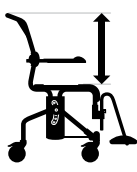

Swift Mobil Tilt-2 XL

B



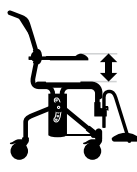

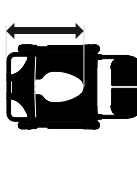
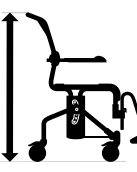
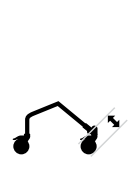
Swift Mobil-2	Swift Mobil-2 XL	Swift Mobil 24"-2	Swift Mobil Tilt-2	Swift Mobil Tilt-2 XL
●	●	●	●	●
●	●	●	●	●
●	●	●	●	●
○	○	○	●	●

							
Swift Mobil-2	93 cm 36½"	57/58/64 cm 22½/22¾/25¼"	45 / 60 cm 17¾" / 23½"	50 cm 19¾"	46,5 cm 18¼"	34 / 46,5 cm 13½" / 18¼"	50 cm 19¾"
Swift Mobil-2 XL	93 cm 36½"	61/64/70 cm 24/25¼/27½"	45 / 60 cm 17¾" / 23½"	50 cm 19¾"	46,5 cm 18¼"	34 / 46,5 cm 13½" / 18¼"	50 cm 19¾"
Swift Mobil 24"-2	106 cm 41¾"	74 cm 29¼"	45 / 60 cm 17¾" / 23½"	50 c 19¾"	46,5 cm 18¼"	34 / 46,5 cm 13½" / 18¼"	50 cm 19¾"
Swift Mobil Tilt-2	102 cm 40¼"	57/58/64 cm 22½/22¾/25¼"	50 / 65 cm 19¾" / 25½"	55 cm 21¾"	46,5 cm 18¼"	34 / 46,5 cm 13½" / 18¼"	50 cm 19¾"
Swift Mobil Tilt-2 XL	102 cm 40¼"	61/64/70 cm 24/25¼/27½"	50 / 65 cm 19¾" / 25½"	55 cm 21¾"	46,5 cm 18¼"	34 / 46,5 cm 13½" / 18¼"	50 cm 19¾"

							
Swift Mobil-2	22/25/28 cm 8¾/9¾/11"	42/48/54 cm 16½/19/21¼"	54 cm (47 cm*) 21¼" (18½"*)	95-110 cm 37½"-43¼"	125 mm 5"	-	16,6 kg 37 lbs
Swift Mobil-2 XL	22/25/28 cm 8¾/9¾/11"	48/54/60 cm 19/ 21¼/23½"	54 cm 21¼"	95-110 cm 37½"-43¼"	125 mm 5"	-	17,3 kg 38 lbs
Swift Mobil 24"-2	22/25/28 cm 8¾/9¾/11"	42/48/54 cm 16½/19/21¼"	67 cm 26¼"	95-110 cm 37½"-43¼"	125 mm 5"	610 mm 24"	25,1 kg 55 lbs
Swift Mobil Tilt-2	22/25/28 cm 8¾/9¾/11"	42/48/54 cm 16½/19/21¼"	60 cm 23½"	100-115 cm 39¼"-45¼"	125 mm 5"	-	20,4 kg 45 lbs
Swift Mobil Tilt-2 XL	22/25/28 cm 8¾/9¾/11"	48/54/60 cm 19/ 21¼/23½"	60 cm 23½"	100-115 cm 39¼"-45¼"	125 mm 5"	-	21 kg 46 lbs

*Art no 8022 9489, 8022 9490, 8022 9491

	 max kg	 max lbs			
Swift Mobil-2	160 kg	135 kg**	352 lbs	297 lbs**	
Swift Mobil-2 XL	160 kg		352 lbs		
Swift Mobil 24"-2	160 kg	135 kg**	352 lbs	297 lbs**	
Swift Mobil Tilt-2	160 kg	135 kg**	352 lbs	297 lbs**	
Swift Mobil Tilt-2 XL	160 kg		352 lbs		

** Art No 8022 9477, 8022 9478, 8022 9479, 8022 9486, 8022 9487, 8022 9488, 8022 9491



Fe	Fe-Cr-Ni	PA	PP
PP/TPV/PA/Fe	PP/TPR	PUR	PES

D

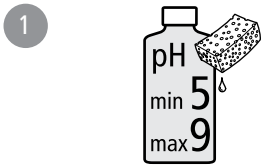

E

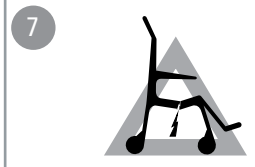
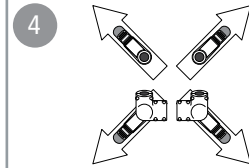
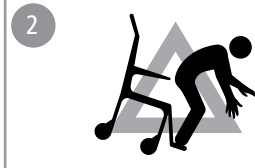
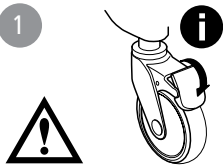

F

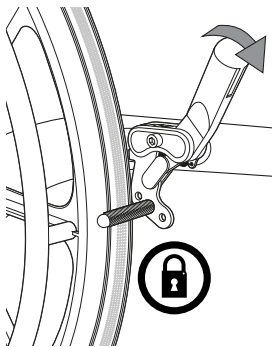
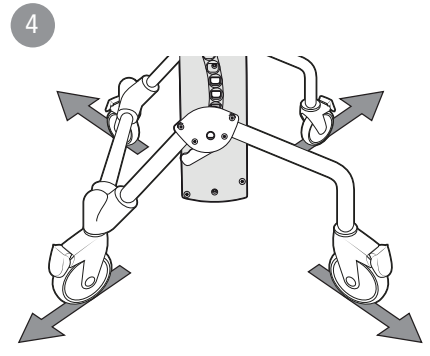
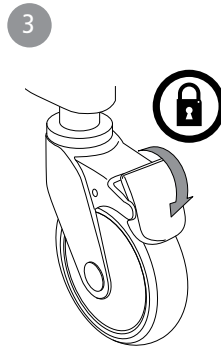
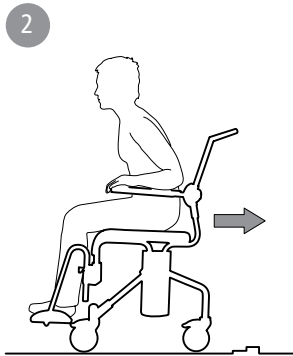
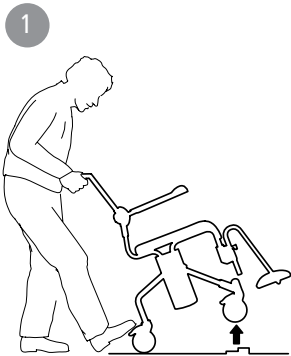

Swift Mobil 24"

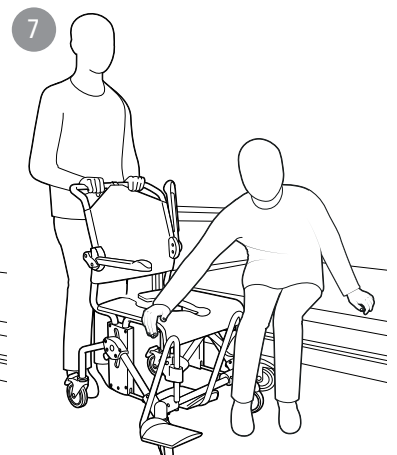
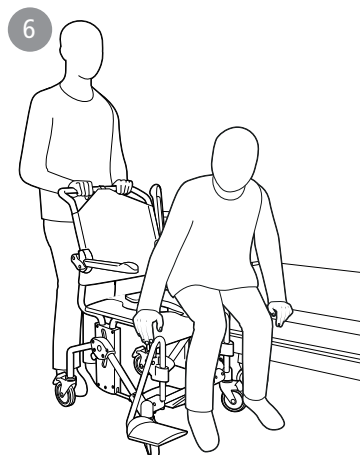
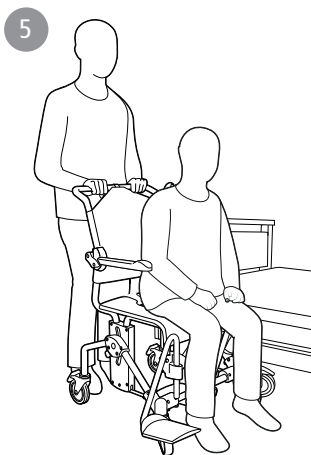

G

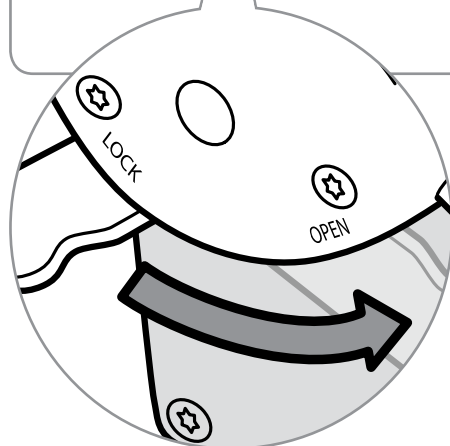
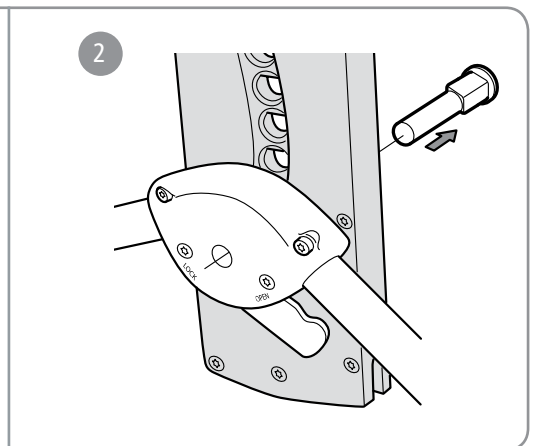
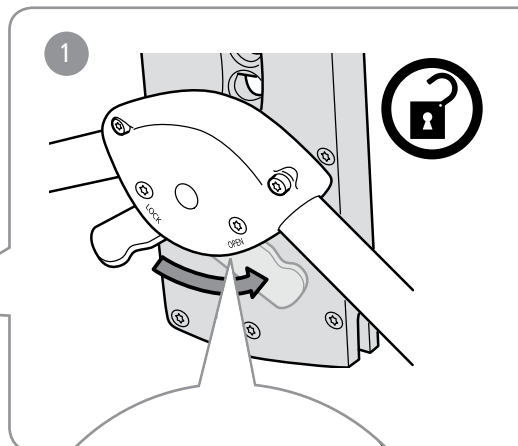
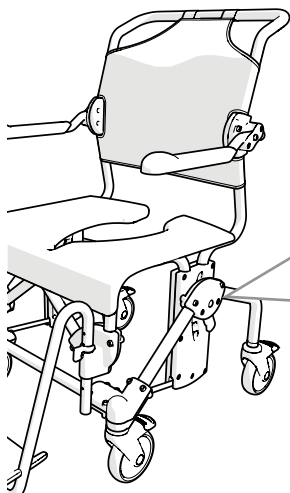

G

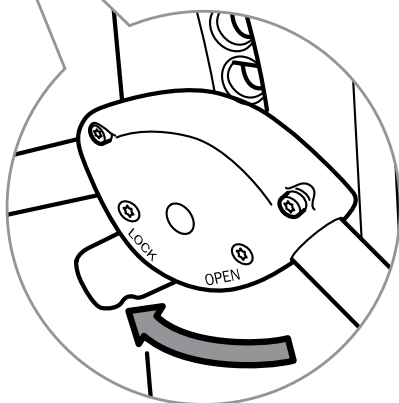
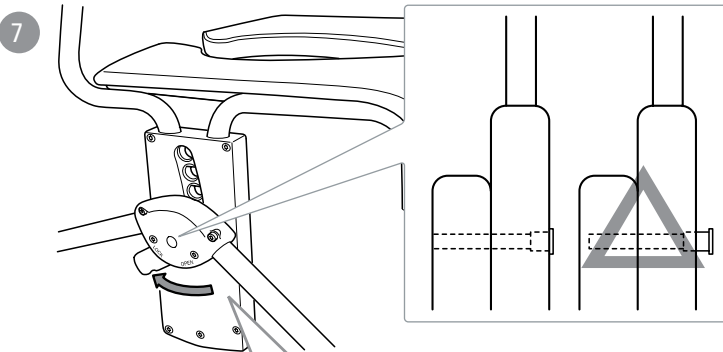
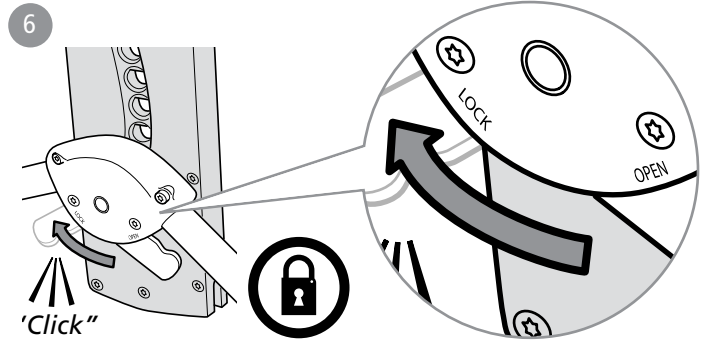
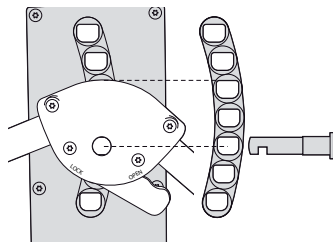
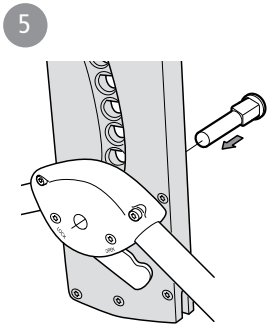
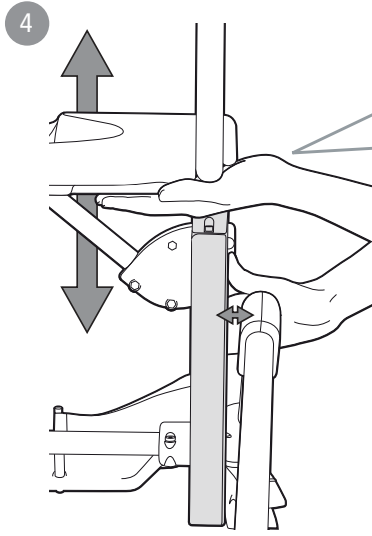
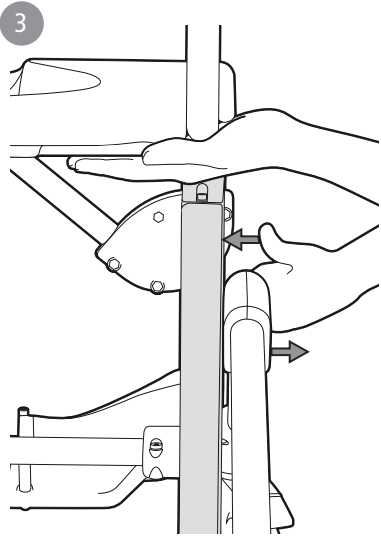

8

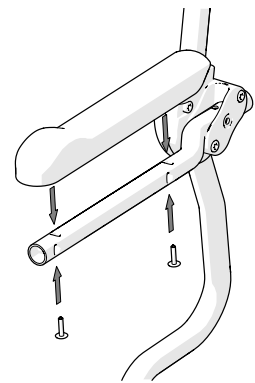
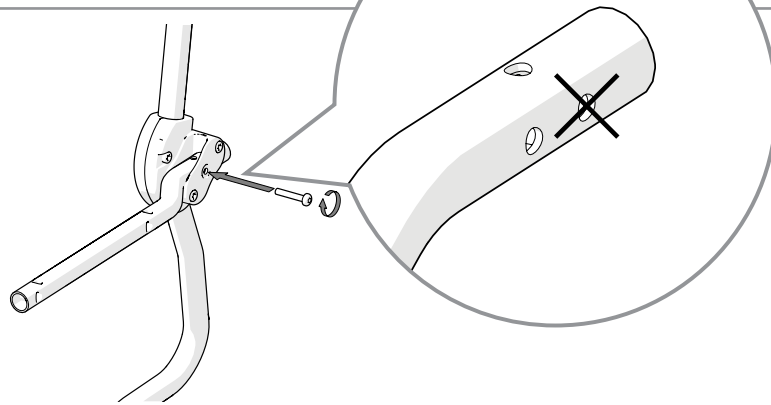
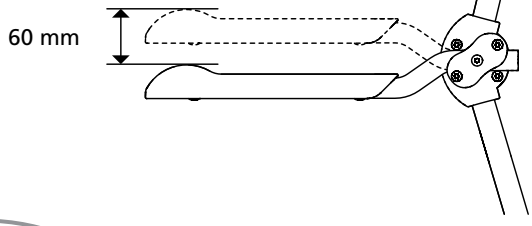
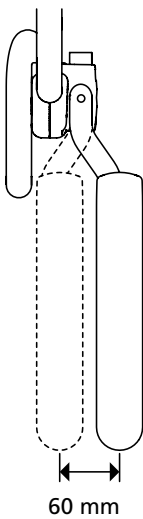
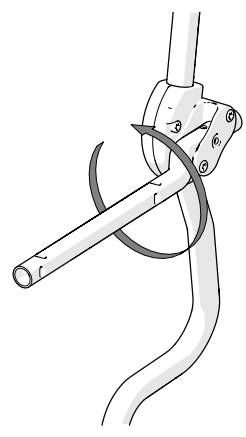
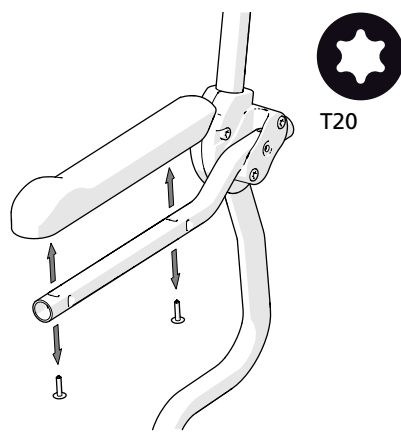
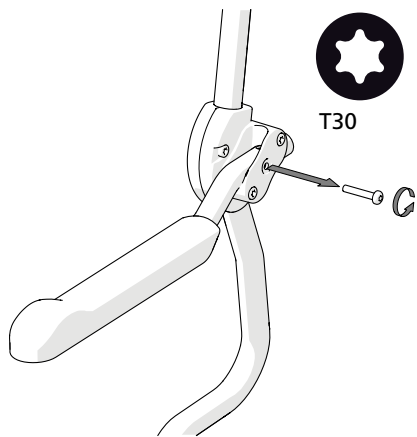

9 **A**
B

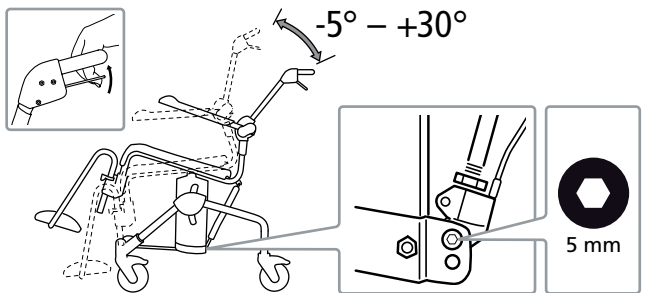

10 **A**
B

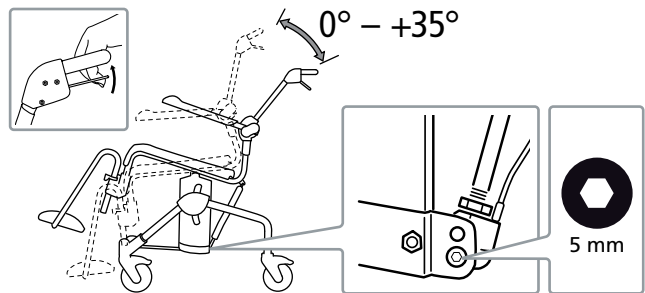

11

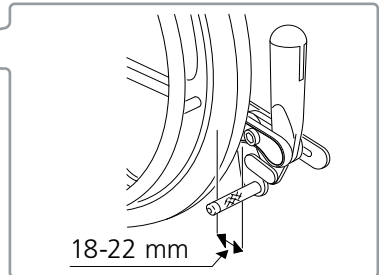
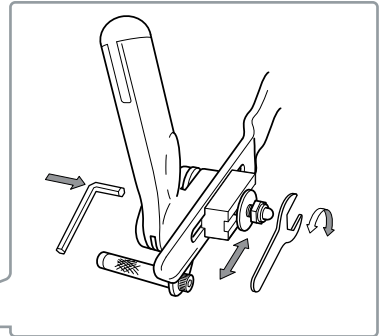
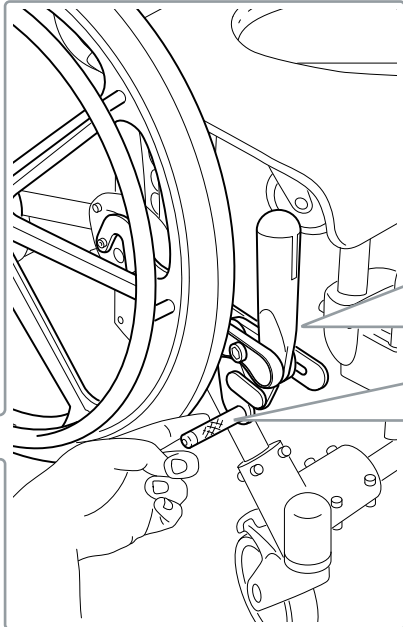
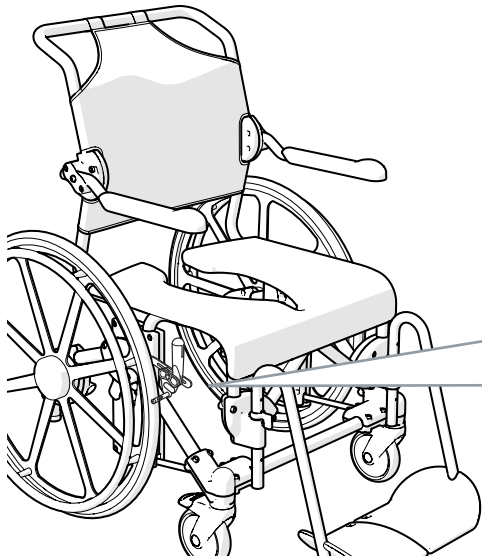

H

1

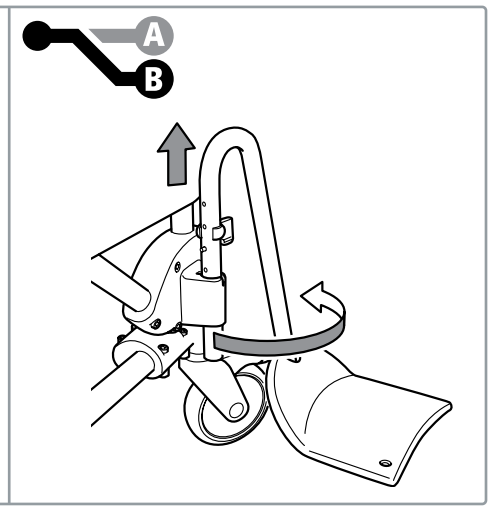
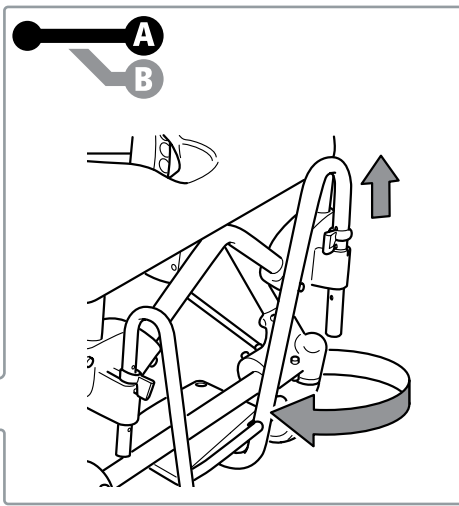
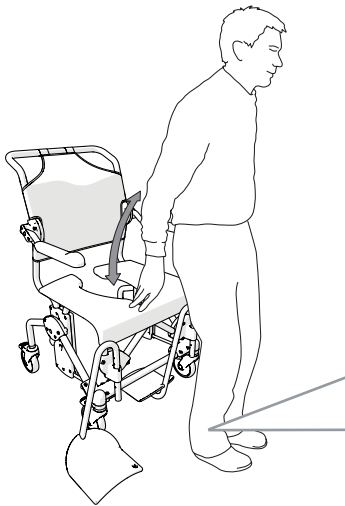

2

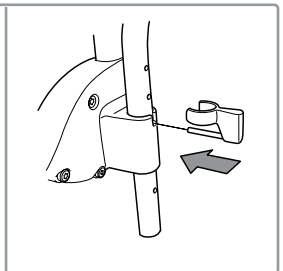
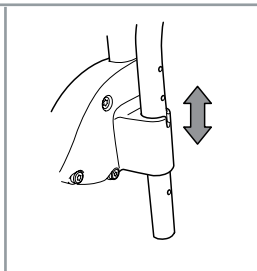
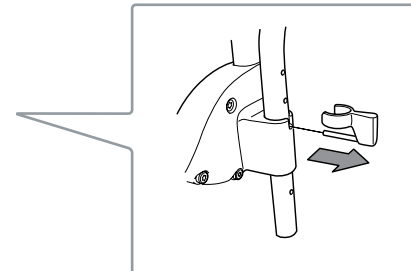
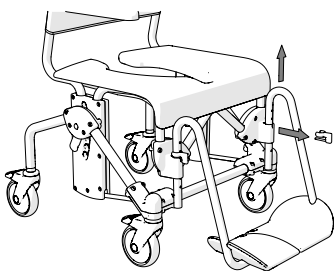





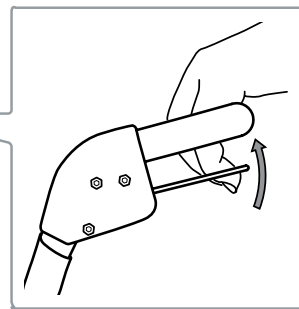
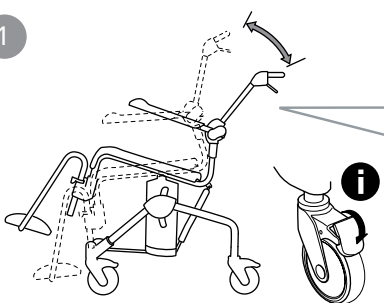



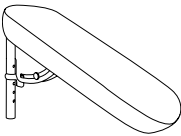
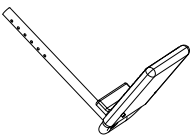

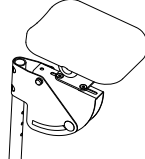
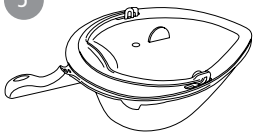
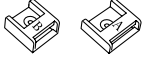
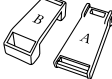
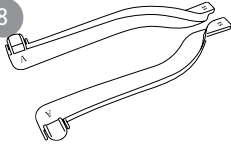
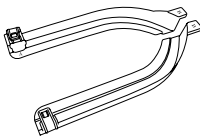
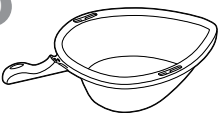
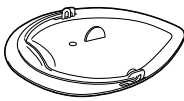
I

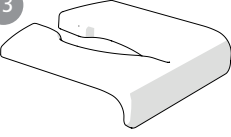
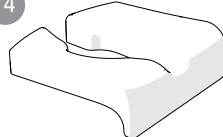
1

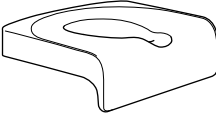
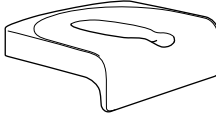
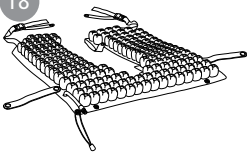
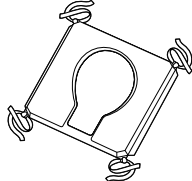
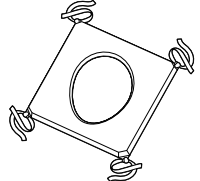

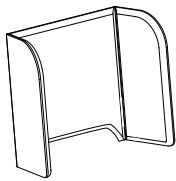
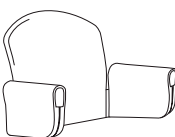
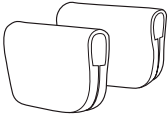
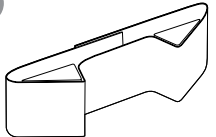
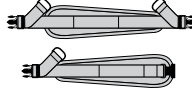
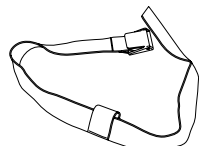
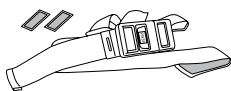
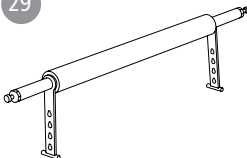
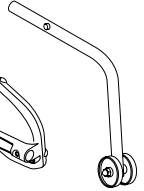
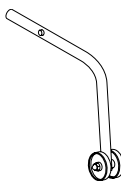
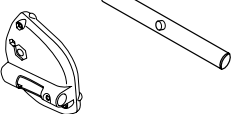
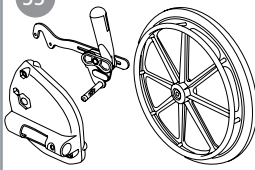
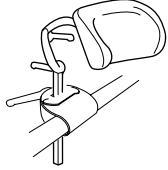
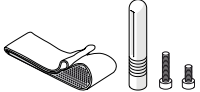
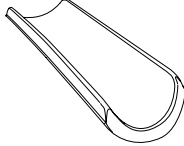
J

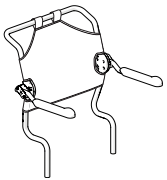
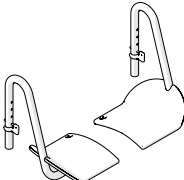
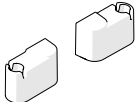
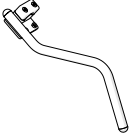
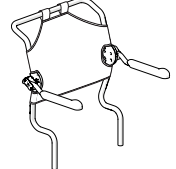
1		2		3		4		5	
6		7		8		9		10	
11		12		13		14		15	
16		17		18		19		20	
21		22		23		24		25	
26		27		28		29		30	
31		32		33		34		35	
36		37		38		39		40	
41		42							

English

General

Thank you for choosing an Etac product.

In order to avoid injury during handling and use, please read through this manual first.

In the manual, the user is the person sitting in the chair. The carer is the person helping the user.

Intended use:

The Swift Mobile 2 family is a range of mobile shower chairs and toilet chairs (hereafter called the product) intended for indoor use when performing hygiene tasks for people with restricted mobility. The product can be used in the shower, at a sink, or over the toilet, as well as for transfers to and from the hygiene room.

The product is intended for use in home environments and institutions.

The product is suitable for use in wet areas, but not pools or similar corrosive environments.

The product is intended to compensate for various types of injuries or disabilities that limit the mobility of the user.

The product is intended for adult users, generally persons who are at least 146 cm tall and who weigh at least 40 kg.

The product is not intended for any other use or environment beyond those stated above.

The product has been tested and complies with the requirements set out in EN ISO 10993-1 and SS EN 12182.

The product conforms to the requirements of the Medical Devices Regulation (EU) 2017/745.

Contra indications:

There are no known contraindications.



This symbol appears in the manual along with text. It indicates instances where the safety of the user or the assistant may be at risk.



The images which are referred to on each page are found at the start of the manual (pages 3 to 11). See Figures A to J for the corresponding text.



This product should be recycled as per national regulations.

Item list: ● = Applies to, ○ = Accessories

See the item list on the right which displays the information applicable to each product.

Swift Mobil-2
Swift Mobil-2 XL
Swift Mobil 24"-2
Swift Mobil Tilt-2
Swift Mobil Tilt-2 XL

Product description

See Figure A

A1. Bolt, **A2.** Leg support, **A3.** Seat, **A4.** Arm support, **A5.** Back support upholstery

A6. Head support

● ● ● ● ●
○ ○ ○ ● ●

Assembly

See Figure B

● ● ● ● ●

Technical data

See Figure C

● ● ● ● ●

Warranty / maintenance

See Figure D

● ● ● ● ●

5-year guarantee against material and manufacturing defects. For terms and conditions, see www.etac.com.

Service life 7 years. For complete information regarding the service life of the product, see www.etac.com.

- D1.** Clean the product with normal non-abrasive cleaning agents (pH value of between 5-9). Rinse and dry. Disinfect the product with an alcohol-based disinfectant, 70%. The product is otherwise maintenance-free.
- D2.** The product and its accessories can be safely cleaned at 85°C for 3 minutes (unless otherwise stated). This applies for reconditioning.

The product can be reconditioned. Refer to the reconditioning instructions at www.etac.com.

Constituent materials are resistant to common disinfectants.

The following surface treatment methods have been used to protect against corrosion:

- Lacquered surfaces = Polyester powder coating
- Non-lacquered steel surfaces = Fe/Zn-Ni

Reuse:

The product is suitable for reuse. The number of times it can be reused depends on how often and in which way the product is used. Before reuse, thoroughly clean and disinfect the product and check its safety features. If necessary, take remedial action.

Safety

See Figure E

● ● ● ● ●



- Defective chairs must not be used.

E6. Risk of crushing with arm supports.

E7. Do not use defective products.

E1. Make sure the castors are locked when users sit down on or get up from the chair.

- An anti-tip attachment must be used if the user is an amputee.

E2. Never stand on the foot supports as there is a risk of tipping!

E3. The sitting position has an impact on stability.

E4. Chair stability is improved if the castors point outward.

E5. See the maximum user weight for your commode chair in the table (page 5).

In case of an adverse event occurred in relation to use of the device, it should be reported to your local dealer and the national competent authority in a timely manner. The local dealer will forward information to the manufacturer.

English

Transfers

See Figure F

Over a threshold:

- F1. Chair only, put one foot on the wheel.
- F2. With user, pull the chair backwards.

In stationary position:

- F3. Always lock as many castors as possible when the chair is to be used in a stationary position.
- F4. Out-turned castors improve the chair's stability.

Transferring:

Assess the risks and take notes. You as a carer are responsible for the safety of the user. Aids should be used if the transfer is deemed as risky. Visit www.etac.com for manual transfer aids.

F3-F4. It is important to ensure that the castors are locked and pointing outward before carrying out transfers to and from Swift Mobil-2.

F5-F7. Fold up the arm support on the transfer side of the chair. Carry out the transfer.

Adjustment

See Figure G

Height:

- G1-G7. The height is easily adjusted by inserting the bolt in the required position. See distances in the technical data section.



Check that both sides have been adjusted to the same height as otherwise stability can be reduced. G7. Do not use the chair if the bolt (orange) is not locked.

Arm supports:

- G8. The height of the arm supports and/or width between the arm supports can be adjusted. Loosen the screws, twist the support to the desired position and retighten the screws. Then loosen and refit the arm support plate in the correct position. Swift Mobil Tilt-2 XL is delivered with the arm supports mounted in the most inward position (seat width 48 cm).

Tilt angle:

- G9. Fit the gas piston in position A to tilt the seat at angles from -5° to 30°
- G10. Fit the gas piston in position B to tilt the seat at angles from 0° to 35°

User brake:

- G11. When adjusting the brake, the brake pin should be set 18 to 22 mm from the rear wheel for good grip.

Leg support

See Figure H

- H1. The assistant can easily raise and swivel the leg supports to the side for the user to sit down in or get up out of the chair. The foot supports are detachable.

- H2. Various height adjustment options are available by moving the locking pin. The leg supports have 6 different height settings.

Tilt function

See Figure I

- I1. The assistant can adjust the sitting angle with ease by holding in the handle and tilting to the required position. Make sure that the wheels are locked if the tilt function is used when the user is sitting in the chair.

Swift Mobil-2	Swift Mobil-2 XL	Swift Mobil 24"-2	Swift Mobil Tilt-2	Swift Mobil Tilt-2 XL
●	●	●	●	●
●	●	●	●	●
			●	●
○	○	●		
●	●	●	●	●
			●	●

English

Accessories

See Figure J

In the section "Accessories", you can see all accessory options available for your product. Variations may occur in different markets. There are restrictions on accessory combinations, for more information, see www.etac.com.



See Figure J	Sw M.-2	Sw M.-2 XL	Sw M. 24"-2	Sw M. Tilt-2	Sw M. Tilt-2 XL	See Figure J	Sw M.-2	Sw M.-2 XL	Sw M. 24"-2	Sw M. Tilt-2	Sw M. Tilt-2 XL
J1. Leg and calf rest, angle-variable	<input type="checkbox"/>	<input type="checkbox"/>	<input type="checkbox"/>	<input type="checkbox"/>	<input type="checkbox"/>	J23. Comfort padding	<input type="checkbox"/>	<input type="checkbox"/>	<input type="checkbox"/>	<input type="checkbox"/>	<input type="checkbox"/>
J2. Footrest	<input type="checkbox"/>	<input type="checkbox"/>	<input type="checkbox"/>	<input type="checkbox"/>	<input type="checkbox"/>	J24. Armrest cushion, pair	<input type="checkbox"/>	<input type="checkbox"/>	<input type="checkbox"/>	<input type="checkbox"/>	<input type="checkbox"/>
J3. Angle adj. footrest	<input type="checkbox"/>	<input type="checkbox"/>	<input type="checkbox"/>	<input type="checkbox"/>	<input type="checkbox"/>	J25. Trunk support	<input type="checkbox"/>	<input type="checkbox"/>	<input type="checkbox"/>	<input type="checkbox"/>	<input type="checkbox"/>
J4. Amputee legrest	<input type="checkbox"/>	<input type="checkbox"/>	<input type="checkbox"/>	<input type="checkbox"/>	<input type="checkbox"/>	J26. Chest and hip positioning belts	<input type="checkbox"/>	<input type="checkbox"/>	<input type="checkbox"/>	<input type="checkbox"/>	<input type="checkbox"/>
J5. Commode pan	<input type="checkbox"/>	<input type="checkbox"/>	<input type="checkbox"/>	<input type="checkbox"/>	<input type="checkbox"/>	J27. Chest belt	<input type="checkbox"/>	<input type="checkbox"/>	<input type="checkbox"/>	<input type="checkbox"/>	<input type="checkbox"/>
J6. Pan-holder attachments	<input type="checkbox"/>	<input type="checkbox"/>	<input type="checkbox"/>	<input type="checkbox"/>	<input type="checkbox"/>	J28. Positioning belt	<input type="checkbox"/>	<input type="checkbox"/>	<input type="checkbox"/>	<input type="checkbox"/>	<input type="checkbox"/>
J7. Attachments for low pan-holder mounting	<input type="checkbox"/>	<input type="checkbox"/>	<input type="checkbox"/>	<input type="checkbox"/>	<input type="checkbox"/>	J29. Crossbar 605 mm	<input type="checkbox"/>	<input type="checkbox"/>	<input type="checkbox"/>	<input type="checkbox"/>	<input type="checkbox"/>
J8. Commode pan holders	<input type="checkbox"/>	<input type="checkbox"/>	<input type="checkbox"/>	<input type="checkbox"/>	<input type="checkbox"/>	J29. Crossbar 665 mm	<input type="checkbox"/>	<input type="checkbox"/>	<input type="checkbox"/>	<input type="checkbox"/>	<input type="checkbox"/>
J9. Bucket holders	<input type="checkbox"/>	<input type="checkbox"/>	<input type="checkbox"/>	<input type="checkbox"/>	<input type="checkbox"/>	J30. Anti-tip stabilisers including bracket	<input type="checkbox"/>	<input type="checkbox"/>	<input type="checkbox"/>	<input type="checkbox"/>	<input type="checkbox"/>
J10. Pan	<input type="checkbox"/>	<input type="checkbox"/>	<input type="checkbox"/>	<input type="checkbox"/>	<input type="checkbox"/>	J31. Anti-tip stabilisers excluding bracket	<input type="checkbox"/>	<input type="checkbox"/>	<input type="checkbox"/>	<input type="checkbox"/>	<input type="checkbox"/>
J11. Lid with handle	<input type="checkbox"/>	<input type="checkbox"/>	<input type="checkbox"/>	<input type="checkbox"/>	<input type="checkbox"/>	J32. Tilter	<input type="checkbox"/>	<input type="checkbox"/>	<input type="checkbox"/>	<input type="checkbox"/>	<input type="checkbox"/>
J12. Splash guard	<input type="checkbox"/>	<input type="checkbox"/>	<input type="checkbox"/>	<input type="checkbox"/>	<input type="checkbox"/>	J33. Rear wheel kit	<input type="checkbox"/>	<input type="checkbox"/>	<input checked="" type="checkbox"/>	<input type="checkbox"/>	<input type="checkbox"/>
J13. Soft Comfort seat, 2 cm high, open at back	<input type="checkbox"/>	<input type="checkbox"/>	<input type="checkbox"/>	<input type="checkbox"/>	<input type="checkbox"/>	J34. Headrest and bracket	<input type="checkbox"/>	<input type="checkbox"/>	<input checked="" type="checkbox"/>	<input checked="" type="checkbox"/>	<input type="checkbox"/>
J14. Soft Comfort seat, 4 cm high, open at back	<input type="checkbox"/>	<input type="checkbox"/>	<input type="checkbox"/>	<input type="checkbox"/>	<input type="checkbox"/>	J35. Heel straps	<input type="checkbox"/>	<input type="checkbox"/>	<input checked="" type="checkbox"/>	<input checked="" type="checkbox"/>	<input type="checkbox"/>
J15. Comfort seat	<input type="checkbox"/>	<input type="checkbox"/>	<input type="checkbox"/>	<input type="checkbox"/>	<input type="checkbox"/>	J36. Hemiplegic armrest	<input type="checkbox"/>	<input type="checkbox"/>	<input type="checkbox"/>	<input type="checkbox"/>	<input type="checkbox"/>
J16. Soft Comfort seat	<input type="checkbox"/>	<input type="checkbox"/>	<input type="checkbox"/>	<input type="checkbox"/>	<input type="checkbox"/>	J37. Armrest lock	<input type="checkbox"/>	<input type="checkbox"/>	<input type="checkbox"/>	<input type="checkbox"/>	<input type="checkbox"/>
J17. Soft Comfort seat - narrow opening	<input type="checkbox"/>	<input type="checkbox"/>	<input type="checkbox"/>	<input type="checkbox"/>	<input type="checkbox"/>	J38. Extended back support	<input type="checkbox"/>	<input type="checkbox"/>	<input type="checkbox"/>	<input type="checkbox"/>	<input type="checkbox"/>
J18. Protect cushion - pressure-relieving	<input type="checkbox"/>	<input type="checkbox"/>	<input type="checkbox"/>	<input type="checkbox"/>	<input type="checkbox"/>	J39. Short leg support	<input type="checkbox"/>	<input type="checkbox"/>	<input type="checkbox"/>	<input type="checkbox"/>	<input type="checkbox"/>
J19. Soft cushion - standard opening	<input type="checkbox"/>	<input type="checkbox"/>	<input type="checkbox"/>	<input type="checkbox"/>	<input type="checkbox"/>	J40. Widening kit for leg support	<input type="checkbox"/>	<input type="checkbox"/>	<input type="checkbox"/>	<input type="checkbox"/>	<input type="checkbox"/>
J20. Soft cushion - oval opening	<input type="checkbox"/>	<input type="checkbox"/>	<input type="checkbox"/>	<input type="checkbox"/>	<input type="checkbox"/>	J41. Anti tip front	<input type="checkbox"/>	<input type="checkbox"/>	<input type="checkbox"/>	<input type="checkbox"/>	<input type="checkbox"/>
J21. Seat cover	<input type="checkbox"/>	<input type="checkbox"/>	<input type="checkbox"/>	<input type="checkbox"/>	<input type="checkbox"/>	J42. Back Swift Mobil-2, upright	<input type="checkbox"/>	<input type="checkbox"/>	<input type="checkbox"/>	<input type="checkbox"/>	<input type="checkbox"/>
J22. Soft back pad	<input type="checkbox"/>	<input type="checkbox"/>	<input type="checkbox"/>	<input type="checkbox"/>	<input type="checkbox"/>						



Special Products and Service

Contact Us

Units 5 and 6 Lower Vicarage Road Southampton
Hampshire
SO19 7RJ
T: 02380 420678
E: info@easycare systems.co.uk